

UC-NRLF



QB 71 227

Theory of Development

By A. H. NIETZ

Monographs on the Theory
of Photography, from the
Research Laboratory of the
Eastman Kodak Company.

No. 2

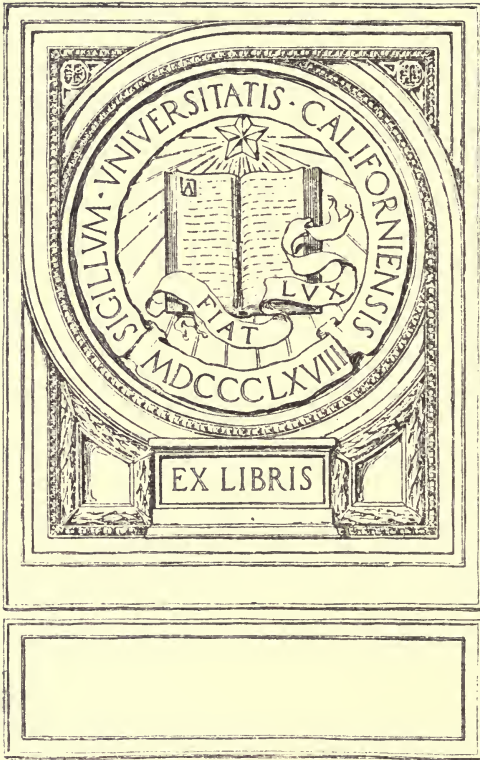

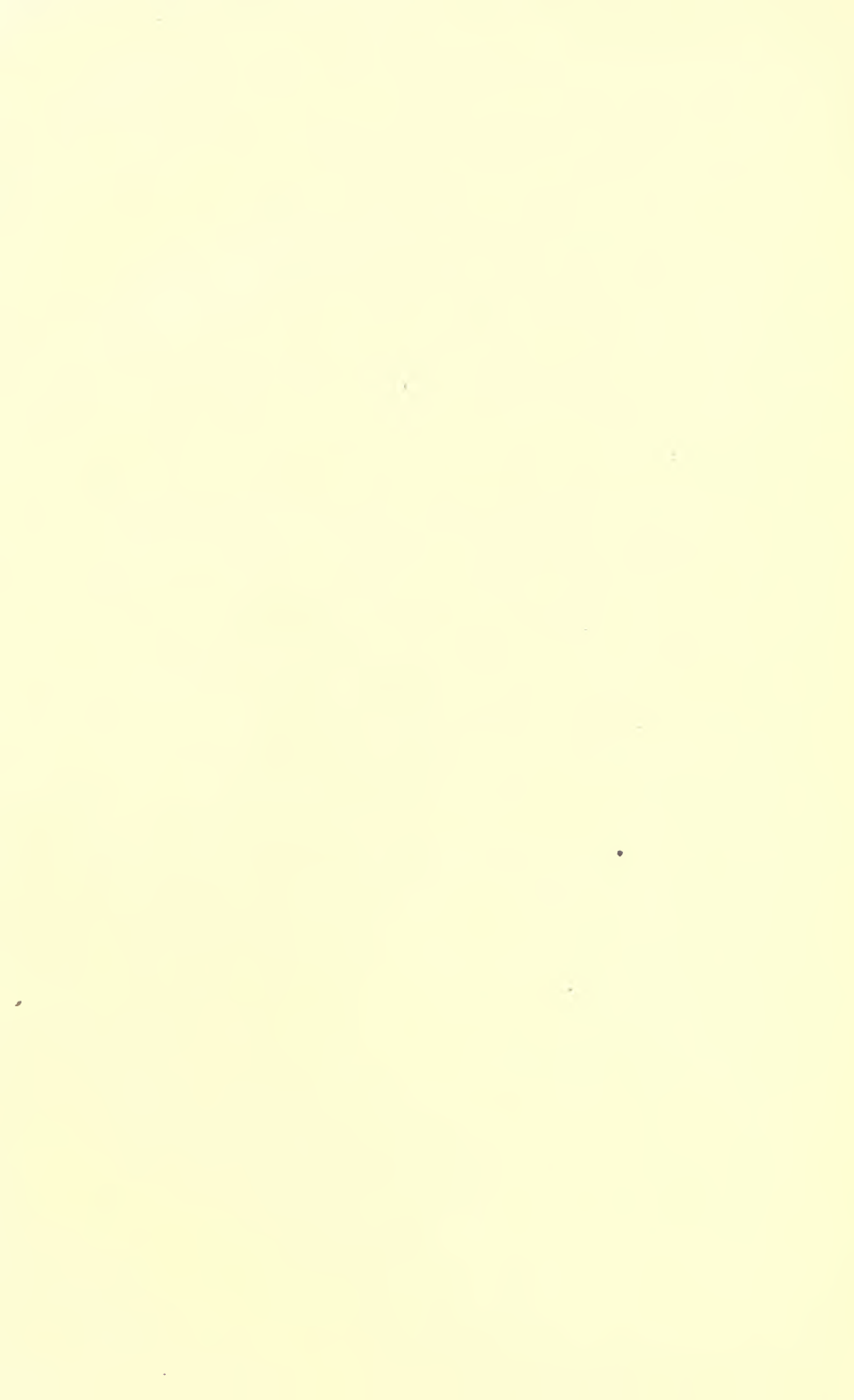

Monographs on the Theory of Photography from the
Research Laboratory of the Eastman Kodak Co.

No. 2

COPYRIGHT 1922
EASTMAN KODAK COMPANY

The Theory of Development

By A. H. Nietz

ILLUSTRATED

D. VAN NOSTRAND COMPANY
NEW YORK

EASTMAN KODAK COMPANY
ROCHESTER, N. Y.

1922

TO THE
LIBRARY OF THE
AMERICAN PHOTOGRAPHIC SOCIETY

TR295
N5

MONOGRAPHS ON THE THEORY OF PHOTOGRAPHY
Edited by
C. E. KENNETH MEES
and
MILDRED SPARGO SCHRAMM

C. B. 1

Monographs on the Theory of Photography

- No. 1. THE SILVER BROMIDE GRAIN OF PHOTOGRAPHIC EMULSIONS. By A. P. H. Trivelli and S. E. Sheppard.
- No. 2. THE THEORY OF DEVELOPMENT. By A. H. Nietz.
- No. 3. GELATIN IN PHOTOGRAPHY. Volume I. By S. E. Sheppard, D. Sc.

Price each \$2.50

Other volumes soon to appear:

- AERIAL HAZE AND ITS EFFECT ON PHOTOGRAPHY FROM THE AIR
- THE PHYSICS OF THE DEVELOPED PHOTOGRAPHIC IMAGE.
By F. E. Ross, Ph. D.
- GELATIN IN PHOTOGRAPHY. Volume II. By S. E. Sheppard,
D. Sc.

Preface to the Series

The Research Laboratory of the Eastman Kodak Company was founded in 1913 to carry out research on photography and on the processes of photographic manufacture.

The scientific results obtained in the Laboratory are published in various scientific and technical journals, but the work on the theory of photography is of so general a nature and occupies so large a part of the field that it has been thought wise to prepare a series of monographs, of which this volume is the second. In the course of the series it is hoped to cover the entire field of scientific photography, and thus to make available to the general public material which at the present time is distributed throughout a wide range of journals. Each monograph is intended to be complete in itself and to cover not only the work done in the Laboratory, but also that available in the literature of the subject.

A very large portion of the material in these monographs will naturally be original work which has not been published previously, and it does not necessarily follow that all the views expressed by each author of a monograph are shared by other scientific workers in the Laboratory. The monographs are written by specialists qualified for the task, and they are given a wide discretion as to the expression of their own opinions, each monograph, however, being edited by the Director of the Laboratory and by Mrs. Schramm, who is the active editor of the series.

Rochester, New York
October, 1922

Preface

The present monograph presents the results of investigations undertaken to determine the reduction potentials of certain organic developers, and to establish the connection between these potentials and the developing characteristics of the various compounds. It was originally intended to use both electrometric and photographic methods, but since the results obtained by the latter method are complete, it has been decided to publish these at the present time.

In the course of the work a large amount of sensitometric data has been accumulated, as well as much information relative to various other aspects of the process of development. The inclusion of what may seem an unwarrantedly large amount of these data seems justified by the desire to render the information obtained as useful as possible for future work as well as to support the various conclusions reached.

The results here presented should normally have been published in a series of papers, but this was prevented by the interruption caused by the war, and though completed in 1919 most of the material is thus published here for the first time.

The author is indebted especially to Dr. W. F. Colby of the University of Michigan, who, during the year in which he was associated with this laboratory, made many valuable suggestions as to some of the conceptions and methods of interpretation employed. Acknowledgment is due also to Mr. Kenneth Huse, who supervised the experimental work for a time.

Rochester, New York
October, 1922.

The Theory of Development

CONTENTS

	Page
PREFACE	7
CHAPTER I. Developing Agents in Relation to their Relative Reduction Potentials and Photographic Properties	13
General Introduction.—The Chemical Structure of Developing Agents and its Relation to Photographic Properties. — Substances Investigated. — Chemical Theory of Reduction Potential Method.—Details of Experimental Work. —Sensitometric Theory.	
CHAPTER II. Developing Agents in Relation to their Relative Reduction Potentials and Photographic Properties (Continued) . .	39
Normal Development and the General Effect of Bromide on Plate Curves.—Experimental Proof of the Existence of the Common Intersection.—Experiments Relating to the Effect of Bromide on the Intersection Point.—Method of Evaluating the Density Depression.—Relation of the Density Depression to Bromide Concentration; Depressions in Different Developers.	
CHAPTER III. Developing Agents in Relation to their Relative Reduction Potentials and Photographic Properties (Continued) . .	52
The Relations for the Slope of the Density Depression Curves.—The Variation of C_0 with the Emulsion Used.—The Variation of C_0 with the Developer; Reduction Potential Values.—Previous Results on Reduction Potentials.—An Energy Scale of Developers.	

CHAPTER	IV.	A Method of Determining the Speed of Emulsions and Some Factors Influencing Speed Importance of the Method of Exposure.—Definitions and Sensitometric Conceptions Involved.—A New View of the Matter.—Experimental Data.	59
CHAPTER	V.	Velocity of Development, the Velocity Equation, and Methods of Evaluating the Velocity and Equilibrium Constants . Previous Work.—Experimental Methods.—Interpretation of Results; Various Velocity Equations and Experimental Data.—Conclusions as to the Form of Equation Best Expressing the Course of the Reaction.	76
CHAPTER	VI.	Velocity of Development (Continued). Maximum Density and Maximum Contrast and their Relation to Reduction Potential and to Other Properties of a Developer The Velocity Equation and its Characteristics.—Note on Experimental Details.—Variation of Maximum Density with Exposure.—Maximum Contrast (γ_{∞}) and a New Method for its Determination.—Variation of D_{∞} and γ_{∞} with the Developer.—The Latent Image Curve.	97
CHAPTER	VII.	Velocity of Development (Continued). The Effect of Soluble Bromides on Velocity Curves, and a Third Method of Estimating the Relative Reduction Potential The General Effect of Bromides on Velocity and on Velocity Curves.—Variation of D_{∞} with Bromide Concentration.—A Third Method for Estimating the Relative Reduction Potential.—Effect of Bromide on D_{∞} .—Proof that the Density Depression Measures the Shift of the Equilibrium.—Effect of Bromide on K .—Variation of t_o and t_a with Bromide Concentration.—The Depression of the Velocity Curves.	112

CHAPTER VIII.	The Fogging Power of Developers and the Distribution of Fog over the Image .	134
	The Nature of Fog.—Fogging Power.—The Distribution of Fog over the Image.—The Fogging Action of Thiocarbamide	
CHAPTER IX.	Data Bearing on Chemical and Physical Phenomena Occurring in Development .	157
	The Effect of Neutral Salts.—The Effect of Changes in the Constitution of the Developing Solution.	
CHAPTER X.	General Summary of the Investigation, with Notes on Reduction Potential in its Relation to Structure, etc.	160

The Theory of Development

CHAPTER I

Developing Agents in Relation to their Relative Reduction Potentials and Photographic Properties

GENERAL INTRODUCTION

Many of the principles relating to the chemistry of development and developers have been so well established that it is unnecessary to reiterate them, except in so far as they are required to make clear the purposes of the present work. In some cases, however, quantitative measurements have been urgently needed, as for instance in regard to the effect of soluble bromides on the development process, which represents the principal portion of the subject matter here.

Chemically, photographic development is now understood to be a reduction process. Many of the features of its mechanism, however, are relatively unknown, as, for example, the differentiation by certain reducing agents between the silver halide which has been affected by light and that which has not. To clear up these matters and to determine the nature of the latent image will require extensive experimental work on details which at first seem to have little bearing on the subject. Although it is impossible at present to rate the various phases of possible investigation according to their importance, it is evident that all effects of development must be eliminated one by one. The study of development characteristics and of the reduction potentials of developers is thus of the greatest importance.

Photographic development may be divided into: (a) physical, where the silver forming the image is supplied by the developer, and on reduction is deposited on nuclei formed by light action; (b) chemical, where the silver is furnished entirely by the silver halide of the emulsion and largely by that portion affected by light; and (c) a combination of the two, in which some chemical development takes place, but, owing to the solvent action of the developer, some of the silver halide of

the emulsion goes into solution from which it is deposited on nuclei or grains of silver already in the emulsion. It is probable that most cases of ordinary alkaline development represent the third class, though the proportion of physical development is usually small, perhaps so small that the process may be considered as belonging to the second class. Physical development is not considered in the present work.

The influence exerted by the developer in conditioning the character and extent of development has caused numerous controversies, most of which could have been avoided if data on developers which cover a wide range had been available. Many of the common developers are much alike, and fall within very narrow limits on a comparative scale; but it should be remembered that a wide range of characteristics is included in the term developer.

Developing agents may be classified as follows:

- (a) Developers of too low reducing energy to be practically useful,—e. g., ferrous citrate;
- (b) Developers giving undesirable reaction products,—e. g., hydroxylamine, hydrazine;
- (c) Developers too powerful for practical use,—e. g., triaminophenol;
- (d) Developers of practical utility,—e. g., paraminophenol, etc.

Eder¹ divides developers into three groups:

- 1. Those which develop a definite quantity of the latent image before fogging sets in. (Common developers);
- 2. Those which develop quite energetically with a minimum of alkali, but at the same time cause fog;
- 3. Those which with a maximum quantity of strong alkali scarcely develop the latent image, but develop fog vigorously, — e. g., phenylhydrazine, paraphenylenediamine sulphonic acid.

It is evident that the common developers occupy similar positions in these classifications, and are likely to have many properties in common,—i. e., those characteristics which make them good developers. Therefore, when investigating the effects of developers, it is necessary to go somewhat outside this range or to obtain a very high degree of precision in the measurements made.

It is obvious also that a number of physical and chemical characteristics other than the relative energy of the compound determine whether or not it is a good developer.

¹ Eder, J. M., *Ausführliches Handbuch für Photographie*, Fifth Edition, 1903, pp. 288 et seq.

Useful criteria for developers, apart from such practical considerations, are:

1. Reducing power (valency);
2. Reduction potential;
3. Velocity (velocity function and magnitude);
4. Temperature coefficient of velocity.

All these are related to the photographic properties of the various substances and furnish not only a basis for quantitative chemical measurement but also the connecting link between such measurements and those of ordinary photographic properties. The second and third of these criteria were selected for investigation.

The reduction potential of a developer, in the sense in which the term is used here, is a practical measure of the reducing energy of the developer.

Bredig, Bancroft Nernst, and Ostwald ⁽¹⁾ have pointed out the importance of the reduction potential in reactions involving chemical reduction, and its analogy to Ohm's law; $\text{Velocity} = \frac{\text{Potential}}{\text{Resistance}}$. In accordance with this analogy, if we allow two developers to act against various additional chemical resistances, such as different concentrations of bromide, the resistances which cause the same change in the amount of work done by the developers should be a measure of their relative potentials. Whether the reduction potential thus measured is identical with the true electrochemical potential is a question which cannot be settled with the information now available; it is certainly related to it.

When applied to photographic development, the analogy to Ohm's law given above may be written in the form.

$$\text{Velocity} = \frac{\pi_1 + \pi_2 + \pi_3 \dots \dots \dots}{R_1 + R_2 + R_3 \dots \dots \dots}$$

where π_1 represents the reduction potential of the developer and is no doubt the largest term of the numerator. The other terms in the numerator correspond to oxidation potentials for the latent image nuclei, a sufficiently high oxidation potential being required (under fixed conditions) to cause reduction, and it being conceivable that different groups of nuclei possess different oxidation potentials. Possibly other factors are included. Undoubtedly the reaction resistance represented by the denominator also consists of several factors or several terms. Thus it is difficult to connect the velocity of development with the reduction potential of the developer

¹ For Citations, see bibliography appended.

in all cases, as the other factors can not be measured by present methods. Only when some of these factors can reasonably be assumed to remain constant can two developers be compared by this method. The velocity of development is affected by diffusion processes to such an extent that any factor influencing the latter changes the velocity, although the potential may have undergone practically no change.

THE STRUCTURE OF REDUCING AGENTS AND ITS RELATION TO PHOTOGRAPHIC PROPERTIES

Before discussing the methods of measurement and the results obtained, it is desirable to review the structure of those organic compounds which have been found to develop, giving some attention to the photographic properties said to be associated with them.

The brothers Lumière with Seyewetz, and, independently, Andresen, are responsible for much of our knowledge of the developing properties of various organic reducing agents. While other authors have contributed to some extent, the many papers of Lumière and Andresen during the past thirty years have established general rules for the structure of compounds which have developing properties. As is now well known, the presence of hydroxyl or amino groups or both is generally essential to developers. The following summary of their rules is taken from the various papers of Lumière and Andresen.¹

Compounds in which the developing function is contained but once. (Two active groups.)

1. These comprise developing substances which contain in one benzene nucleus at least two $-OH$ groups or two $-NH_2$ groups, or one $-OH$ and one $-NH_2$ group;
2. These substances develop only if the groups are in the para- or ortho- positions. The meta- compounds have not been found to develop, so far as known;
3. Developers having the two groups in the para- position are more powerful than those in which the groups are in the ortho- position;
4. The dioxybenzenes are more powerful than the aminophenols, which in turn are more powerful than the diaminobenzenes;
5. The developing properties are not injured by the presence of more amino or hydroxyl groups;

¹ See Bibliography.

6. In the naphthalene series it is not necessary that both groups be attached to the same benzene nucleus. The general rules governing developing function do not apply to compounds of this series;

7. Substitution in the amino or hydroxyl groups disturbs the developing properties when at least two such groups in the molecule do not remain intact. (Andresen disagrees with this, finding some cases where the developing properties are destroyed by such substitutions and others where they are unchanged or even increased.)

It has been stated that alkyl substitution in the amino-group increases the developing energy. Apparently substitution for the hydrogen of the hydroxyl group lowers the developing energy or destroys the developing properties altogether;

8. Substitution of acid groups (COOH , SO_3H , etc.) for hydrogen in the benzene nucleus lowers the energy;

9. Substitution of chlorine or bromine for hydrogen in the benzene nucleus increases the developing energy;

10. With two hydroxyl groups only, alkali is needed;

11. With two amino groups only, or with one $-\text{OH}$ and one $-\text{NH}_2$ group the developer functions without alkali.

Compounds in which the developing function is contained more than once (three or more active groups).

12. Substances of the benzene series containing three active groups in symmetrical arrangement (1, 3, 5) have no developing power. The other groupings differ in energy, no definite rule being established;

13. The hydroxy-phenols which contain the developing function twice (three $-\text{OH}$ groups) can develop without alkali but are not practical when so used;

14. If the reducing agent contains a mixture of three or more $-\text{OH}$ and $-\text{NH}_2$ groups the developing energy is greater without alkali than it is with alkali when the developing function exists singly.

Increasing the number of amino groups greatly increases the energy;

15. In substances like substituted diphenyl the developing energy is not increased by the introduction of a third group in the second nucleus;

16. In the naphthalene series the introduction of a third group raises the developing energy, regardless of the nucleus to which it is joined.

*General effects of substitution in a benzene compound already a developer.*¹ (Two active groups.)

(a) Substitution of a halogen for hydrogen of the benzene nucleus in a para- or ortho- hydroxy- or amino-phenol raises the energy. (The same substitution in the meta- compounds has no effect on their inactivity);

(b) Substitution of an alkyl group in the nucleus has no effect on the developing energy;

(c) Substitution of acid groups in the nucleus lowers the energy;

(d) Substitution of an alkyl group in the $-OH$ group of hydroxy- or amino-phenols destroys the developing properties;

(e) Substitution of an alkyl group in the $-NH_2$ group of an amino-phenol raises the reduction potential;

(f) Any or all of the hydrogen atoms of the amino groups in an amine may be substituted by alkyl groups, thus increasing the reduction potential;

(g) If the $-NH_2$ group of an amino-phenol or diamine be substituted to give a glycine the reduction potential is lowered;

(h) The reduction potential is increased by substituting a third active group in the nucleus. This substitution makes the meta compounds developers if the third group is not in the symmetrical position.

The above summarizes those conclusions of Lumière and Seyewetz and of Andresen, which apply to substances within the ordinary range.

Valuable as these so-called "rules" have been, it is probable that some of them would be discredited could the necessary measurements be obtained. While in general they are correct as to the kind of substances which possess the developing function to any degree, they are wrong in certain respects as to the relative energies possessed by the substances in question, especially as to the effect of certain substitutions on the developing energy. We know of no accurate quantitative experimental work in photography except the limited results of Sheppard, and of Sheppard and Mees, which could possibly justify and support these conclusions as to the effects of structure. While admittedly correct in many cases, the conclusions must have been reached mainly by *a priori* chemical reasoning, as they were evidently submitted to only rough qualitative tests, which are by no means conclusive.

¹ Compiled from the above rules.

The molecular structure of the reducing agent undoubtedly has a considerable effect on the developing properties in so far as it influences or conditions the several specific properties of the reducer, but a classification of developers on the basis of free molecular energy alone would not agree, strictly at least, with a classification made according to developing properties. At present there is no method for determining the true chemical affinity or reduction potential of the developing agent *per se*, and therefore the classification of organic reducers given is made according to apparent developing properties; and what is referred to as reduction potential is relative energy from the standpoint of practical development.

To furnish evidence on the question of structure especially it was proposed to study the reduction potentials and developing characteristics of a large number of compounds. Although this plan has not yet been completed, much work has been done on many of the substances.

Table 1 shows part of the original plan. The compounds marked "X" in Table 1 and those listed in Table 2 have been examined.

This investigation has been limited by the very great difficulties encountered in the course of the work. In the first place, it was found practically impossible to prepare some of the compounds required in a sufficiently pure state. From the experience of the Organic Chemical Department of this laboratory in the preparation of substances of this character, it is doubtful whether some of the photographic developing agents mentioned by previous investigators have ever been prepared in such a form that their real photographic properties could be determined. Other difficulties arose in working out suitable experimental methods and in securing sufficiently accurate and reliable data. However, the results of the experimental work here presented are given with a very reasonable assurance that they are the best obtainable under the most favorable conditions. Photographic research of this kind is an especially slow, tedious, and expensive process, a fact which is not always fully appreciated.

CHEMICAL THEORY OF THE METHOD EMPLOYED IN DETERMINING REDUCTION POTENTIAL

The principal method employed in determining relative reduction potentials depends on the restraining action of soluble bromides when used with the reducers in question, a method first applied by Sheppard¹. A soluble bromide,

¹ Sheppard, S. E., Theory of alkaline development. J. Chem. Soc. 39: 530. 1906.

Table I

SYSTEMATIC STUDY OF DEVELOPING PROPERTIES







	Two -OH groups para	Two -OH groups ortho	Two -NH ₂ groups para	Two -NH ₂ groups ortho	One -OH + one -NH ₂ para	One -OH + one -NH ₂ ortho
Nuclear methylation						
Side-chain methylation						
Third reactive group	-OH 					
	-NH ₂ 					
Chlorination						
Nuclear and side-chain methylation						
Change to Glycine						

The reduction potentials and developing characteristics of the compounds marked "X" have been studied.

Table II

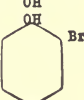
ADDITIONAL COMPOUNDS WHICH HAVE BEEN EXAMINED FOR
REDUCTION POTENTIAL AND DEVELOPING CHARACTERISTICS

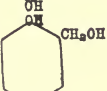
Ferrous oxalate

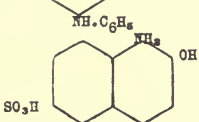
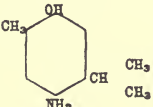
	Pyrogallol
	Phenyl hydrazine
	Dichlor hydroquinone
	Brom hydroquinone
	Dibrom hydroquinone
	Edinol
	Duratol
	Eikonogen
	paramino carvaerol

$\text{NH}_2.\text{OH}.\text{HCl}$. Hydroxylamine hydrochloride.

such as potassium bromide, may affect development (i. e., may exert restraining action) in two and possibly three ways. (It is understood that the development of a silver bromide emulsion is under consideration.)

1. Soluble bromides, being reaction products of a reversible reaction, such as

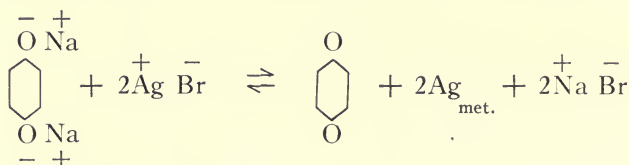

lower the driving force of the reaction in the forward direction. This view was first presented by H. E. Armstrong, and later adopted by Hurter and Driffeld and by Luther.¹

2. The bromide depresses the concentration of silver ions by the action of the common anion, Br,—a theory first due to Abegg.²

3. The bromide may have a specific action on the silver halide other than that mentioned in 2. Concerning such a possibility we have little knowledge, but various phenomena occurring at high concentrations of bromide indicate effects quite different from those described in 1 and 2. (Chapter IX.)

Abegg, applying physico-chemical laws, considered development as consisting of two simultaneous processes—oxidation of the developer $\bar{\text{R}}^- \rightarrow \bar{\text{R}}$, and reduction of the silver ion $\text{Ag}^+ \rightarrow \text{Ag}_{\text{met.}}$ each tending to reach equilibrium as defined

by fixed values of the ratios $\frac{[\bar{\text{R}}]}{[\bar{\text{R}}]}$ and $\frac{[\text{Ag}^+]}{[\text{Ag}_{\text{met.}}]}$.

For a “strong” developer the value of the equilibrium ratio for the reaction $\text{Ag}^+ \rightarrow \text{Ag}_{\text{met.}}$ is greater than for a “weak” one—i. e., the stronger developer can reduce silver from a solution weaker in silver ions (richer in bromine ions). The bromide susceptibility is therefore a measure of the developing potential of the reducing ion.

Further, for the reaction above,² the potential of the reducing ion $\bar{\text{R}}^-$ in the process of losing one electron at equilibrium is $RT \log \frac{[\bar{\text{R}}]}{[\bar{\text{R}}]}$ and this must be equal (but opposite in sign) to

¹ For citations, see bibliography appended.

² Sheppard—for citation, see bibliography.

that of Ag^+ in acquiring one electron— $RT \log \frac{[\text{Ag}^+]}{[\text{Ag}_{\text{met.}}]}$.

$$\text{Also, } \frac{[\text{Ag}^+][\bar{\text{Br}}]}{[\text{AgBr}]} = K.$$

And since $[\text{AgBr}]$ is in excess and may be considered constant,

$$[\text{Ag}^+][\bar{\text{Br}}] = K \text{ and } [\text{Ag}^+] = \frac{K}{[\bar{\text{Br}}]}.$$

Hence, the potential of the ion $\bar{\text{R}}$ in passing to the higher oxidation stage $\bar{\text{R}}$ may be written

$$\begin{aligned} -A &= RT (\log [\text{Ag}^+] - \log [\text{Ag}_{\text{met.}}]) \\ &= RT (\log k - \log [\bar{\text{Br}}] - \log [\text{Ag}_{\text{met.}}]) \end{aligned}$$

where k is the dissociation constant of the silver bromide and $\log [\text{Ag}_{\text{met.}}]$ is a constant (for fixed exposure), $\log [\bar{\text{Br}}]$ being the only variable in the right-hand member.¹ Hence the reduction potential varies with $\log [\bar{\text{Br}}]$, or the logarithm of the concentration of bromine ions corresponding to the equilibrium value of $\frac{[\text{Ag}^+]}{[\text{Ag}_{\text{met.}}]}$.

The above is based on the assumption that the bromide acts chiefly by depressing the dissociation of the silver bromide, which is probably the case. However, taking all the evidence into account, it is not justifiable to assume that it is ever the only effect, or always the chief one. The form of the function relating reduction potential to bromide concentration is therefore unknown, and no assumptions will be made regarding it. For simplicity the results interpreted as relative reduction potentials are considered as measured by the concentrations of bromide involved.

It should be especially noted also that in the present investigation the relations are not expressed in terms of the concentrations of the bromine ion, but in terms of potassium bromide concentrations, this being a logical procedure until the true relations are established. The reduction potentials as measured by the methods employed will be in the proper order, if not of the right magnitude, and all the results may be converted when further information warrants.

In accordance with the deduction made above Abegg suggested as a measure of the potential the amount of bromide

¹ The author is indebted for this suggestion to Dr. S. E. Sheppard.

against which a reducing agent can just develop. But, as Sheppard points out, this method fails with most organic developers because the oxidation products are not stable and their concentrations are indeterminate. Hence the equilibrium condition is not maintained by $\frac{[\bar{R}]}{[R]}$ and the energy is a function of the time.

Sheppard's method was to compare the concentrations of bromide required by different developers to produce the same depression in density at the same degree of development. But Sheppard did not give any clear quantitative relation as the basis of his method, and certain of the conclusions reached were erroneous through lack of sufficient data. By use of experimental results now available, however, the method, with modifications, can be justified. Its bearing, in terms of well established chemical theories of reduction potential, is still somewhat obscure. It is believed that when certain electrochemical data are secured the relationship will be established. At any rate, the photographic action of bromide has been thoroughly investigated and some definite conceptions have resulted.

It may be assumed from data given below that:

1. The presence of bromide causes an increase in the reaction resistance;

2. The more powerful the developer, the greater the concentration of bromide against which it can force the ratio

$\frac{[Ag]^+}{[Ag_{met.}]}$ past the value at which metallic silver is precipitated.

That is (as stated above), a powerful developer can develop in the presence of a higher concentration of its reaction products than a weak one, or it can reduce silver from a solution weaker in silver ions. Also, the more powerful the developer, the greater the concentration of bromide required to produce a given change in the amount of work done;

3. The bromide susceptibility is a measure of the potential of the reducing ion, though the quantitative relations are not definitely known at present;

4. The bromide susceptibility may be measured by the concentration of bromide required to produce a given change in the amount of work done;

5. The change in the total amount of work which can be done may be found photographically by determining the shift of the equilibrium—i. e., the lowering of the maximum or equilibrium value of the density for a fixed exposure. The

reduction potentials will then be related as the concentrations of bromide required to produce the same amount of change, or more probably as the logarithms of these concentrations.

The last is essentially the principle of Sheppard's method, although it could not be shown at the time that the quantity measured was the shift of the equilibrium.

It will be shown that several methods place developers in the same order, and much indirect evidence indicates that the fundamental conceptions of the theory are correct or nearly so.

DETAILS OF THE EXPERIMENTAL WORK

It now becomes necessary to consider some of the basic principles of those quantitative photographic methods which are often incorrectly grouped under the term sensitometry. Various details of the experimental work are presented first, as leading up to the interpretation of the data.

The methods adopted are similar to those of Hurter and Driffield and of Sheppard and Mees. For the convenience of readers not familiar with the work of these investigators, it is reviewed below in so far as is necessary to an understanding of the principles involved.

To obtain quantitative measurements of the character of a photographic plate, or to determine the effect of any factor on the development process, it is necessary to carry out the following steps:

- (a) Exposure of the plate in a definite manner, for a definite time;
- (b) Development under known conditions;
- (c) Measurement of the resulting deposit of silver;
- (d) Interpretation of the data obtained.

The extent to which this plan is followed depends of course on the information desired. For the present purpose certain phases of the work are necessarily quite extensive. For example, while the effect of a wide range of exposures is not studied, the development of the plates is carried out for a long time under varied conditions, and the data are carefully studied. The physical side of the photographic process may be ignored so long as the necessary conditions are constant throughout. Thus photographic methods are turned to the uses of chemistry, and the present investigation is therefore as much a chemical as a photographic one.

(a) Exposure of the Sensitive Material.

The plates were exposed in a sensitometer, or exposing machine, which by means of an electrically controlled sliding metal plate placed immediately in front of the sensitive

material exposes the latter in a series of steps for known times to a standard light source. This type of sensitometer has been described by Jones.¹ The light source used was the acetylene burner described by Mees and Sheppard,² screened to average daylight quality with a Wratten No. 79 filter. The times of exposure represent a logarithmic exposure scale, or a series of times increasing by consecutive powers of some number, usually 2, $\sqrt{2}$, or 1.58 (of which $\log_{10} = 0.2$). This scale is used because it is found that the blackening produced upon development increases with the increase of exposure

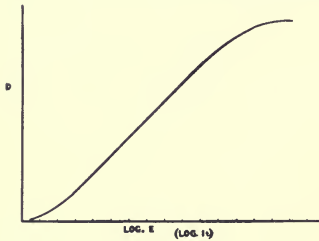

Fig. 1

(exposure = product of light flux multiplied by the time) in such a way that the darkening, expressed in terms of density plotted against the logarithm of the exposure, gives a curve which shows the character of the emulsion. Such a curve is generally referred to as an H. and D. curve. (See Fig. 1.) The density is defined as follows:

T = transmission of the deposit on the developed plate;

$\frac{1}{T}$ = opacity of the deposit = O ;

$\log_{10} O$ = density = D .

Using a logarithmic scale of exposures as abscissae and D as ordinates, it is evident that the successive pairs of exposure steps will be separated by equal distances on the horizontal axis.

D is proportional to the amount of metallic silver present in a given area of the deposit under average conditions. The H. and D. curve therefore shows the relation between the amount of silver deposited and the exposure for a fixed degree of development.

(b) Method of Development.

To insure standard conditions during the development of the plates it is necessary to provide for efficient stirring of the developer, to maintain a constant temperature, and to see that the times of development are accurate. The question of stirring during development is a rather troublesome one, as some developers require much more vigorous stirring than others to ensure uniform development. This of course means

¹ For citation see bibliography.

² Mees, C. E. K., and Sheppard, S. E., New investigations of light sources. Phot. J. 59: 287. 1910.

that it is more necessary to keep the oxidation products thoroughly washed out of the emulsion in some cases than in others.

There are two disadvantages in the use of a tray for developing. First, the mechanical rocking of a tray (motion in a vertical plane) is very likely to produce streaks, though when this is done by hand the motion is more irregular and the results are better. Secondly, a large surface of the developer is exposed to the air. The use of a water-jacketed tube as shown in Fig. 2 does away with these objectionable features.

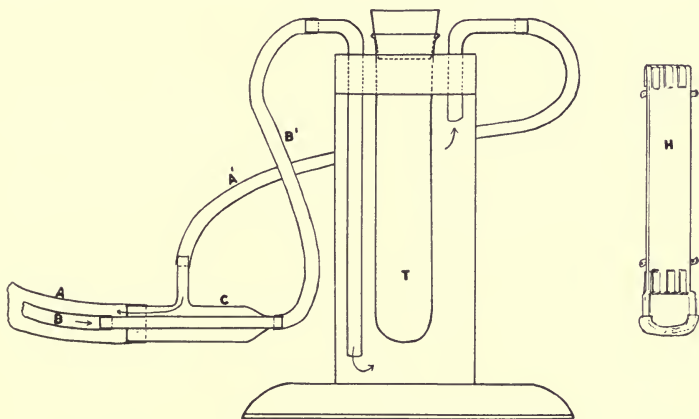

Fig. 2

This apparatus consists of a heavy glass tube T, seven inches long and one and one-quarter inches in diameter, within a stoppered glass jar. The space surrounding the inner tube is filled with water at 20° C. from a centrifugal pump in a thermostat. Concentric rubber tubes, A and B, with a metal connector C, connect with the pump so that the water from the pump is thermally shielded by the water returning to the thermostat. A' and B' are flexible rubber tubes connecting with the water-jacket. The plates used were one inch wide by four and one-quarter inches long and were developed two at a time in the silver-plated holder H, shown at the side. The prongs at the bottom of the holder were fitted with soft rubber to prevent breakage of the inner tube. About 60 cc. of developer were poured into the tube T, the plate holder and stopper inserted, and the whole was shaken by hand.

This quantity of developer left an air space large enough to assure thorough shaking, which was aided by the movement of the plate holder.

Sufficient skill was acquired in the use of this device to make possible a time of development of fifteen seconds with an accuracy of ten per cent. For longer times greater accuracy was obtained. Various timing devices were used. Fresh developer was used for each pair of plates. In some cases it was necessary to economize on developer because of the small quantity of developing agent obtainable compared with the large amount of experimental work for which it was to be used. The water-jacketed tube described was especially advantageous in this respect.

A silver-plated metal water-jacketed tray provided with a cover was used for some of the work, and for very long times of development a silver-plated cylindrical water-jacketed tank, fitted with a revolving shaft with fan stirrer at the bottom and holders for the two plates mounted above the stirrer was useful. The shaft was revolved slowly by means of an electric motor.

The three developing apparatus were compared on numerous occasions. No definite conclusions were reached as to which gave most uniform results, but for constant use it was found that glass vessels like the developing tube first described are rather more satisfactory than the metal containers as the silver plating wears off and the exposed metal is apt to cause trouble.

Developers Used. In all comparisons of developing agents the same concentrations of the necessary ingredients were used. The formula adopted is:

Developing agent	M/20;
Sodium sulphite	50 gms.;
Sodium carbonate	50 gms.;
Water to	1000 cc.

In some cases the sodium carbonate was omitted, and in some cases caustic soda was used. These exceptions are noted in the tables. The concentration M/20 was used except in those cases where the developing agent was not soluble in this proportion. Exceptions are noted in the tables. On the whole, the concentrations in the above formula give satisfactory developers, though not necessarily as good as could be made in individual cases by careful adjustment of the concentrations of the various constituents.

As previously shown by Sheppard and Mees,¹ Luther and Leubner,² and Frary and Nietz,³ a developer like that indicated by the above formula represents a very complex chemical system. Apparently the developing agent and the sodium carbonate react to form phenolates to an extent depending on equilibrium conditions, and probably there is a reaction between the sulphite and the developing agent or its phenolates. The various reaction products then hydrolyze and dissociate, so that the developing properties depend on a very complicated adjustment. It is obvious that in the absence of definite knowledge of these reactions a comparison of two developing agents under identical chemical conditions is impossible. Even with standard concentrations of alkali and sulphite there is no assurance that hydroquinone used in the above formula is under chemical conditions identical with those under which paraminophenol would be. The hydroquinone probably forms a mixture of the two phenolates which reacts to a certain extent with the sulphite. These reactions would be different or proceed to a different equilibrium point with paraminophenol, and the state of the two systems would be different also because of variations in the degrees of hydrolysis and dissociation.

The best that can be done at present, therefore, is to use a standard method of comparison by employing always the same concentrations. This will give the right order as to the reducing energy of most developers, though not properly distinguishing between those nearly alike. It should be pointed out that for these reasons (as well as for others previously mentioned), the photographic method cannot be used for determining the true relative affinities of the reducing agents themselves, but it is valuable in giving a classification of these substances as developers when used in the ordinary way. From the standpoint of photographic theory the latter is more important.

Emulsions used. Seed 23 and Seed 30 emulsions were used for most of the experiments, though a number of special emulsions (noted below) were prepared. Eastman Portrait film was also used. Though much of the work was done with plates, film is more satisfactory in many ways.

¹ Sheppard, S.E., and Mees, C. E.K., Investigations on the theory of the photographic process.

² Luther, R., and Leubner, A., The chemistry of hydroquinone development. *Brit. J. Phot.* 59: 632, 653, 673, 692, 710, 729, 749. 1912.

³ Frary, F. C., and Nietz, A.H., The reaction between alkalies and metol and hydroquinone in photographic developers. *J. Amer. Chem. Soc.* 37: 2273. 1915.

(c) Measuring the Silver Deposits.

The density (silver deposit) was determined by measuring the amount of light transmitted, using the Martens photometer. Special precautions were taken to minimize the effects of stray light in and around the instrument. Measurements were made with the emulsion side of the negative in contact with a diffusing surface, a piece of ground pot opal glass being used. For the high densities a powerful light, housed in, with a pair of condensers, was used, and a compensating photographic density was placed in the comparison field to increase the accuracy of reading. The densities as read and used represent the total deposit, no subtraction of the fog reading being made. Reasons for this will be given in the chapter on the distribution of fog.

(d) Interpretation of the Data.

In order to understand fully the results obtained in the experiments, it is necessary to interpret them according to certain fundamental principles which are reviewed in the next section.

SENSITOMETRIC THEORY

I. PRINCIPLES ESTABLISHED BY OTHER INVESTIGATORS.

The results obtained by Sheppard and Mees confirmed and amplified those of Hurter and Driffield in the field of quantitative photographic research. The significance of the H. and D. curve, the general character of which was shown in Fig. 1, has been mentioned. Although in the figure the curve is drawn as having a considerable straight line portion any equation representing it must indicate that it has a point of inflection and with certain emulsions precise measurements show this to be the case. However, under most conditions (within the errors of observation), a considerable portion of the curve is a straight line. In the present work emulsions giving a rather long straight line region were used, and in the later discussion the "toe" and "shoulder" of the curve are not considered.

The straight line portion of the curve has the equation

$$D = \gamma (\log E - \log i)$$

where γ is the slope, and $\log i$ is the intercept on the $\log E$ axis. γ is termed the development factor, $\log i$ the inertia point, and i the inertia (expressed in the proper exposure units).

If a number of plates which have been given the same exposure in the sensitometer are developed under constant

conditions for varying times, the densities plotted against $\log E$ as before give a series of curves for the different times of development of the kind shown in Fig. 3.

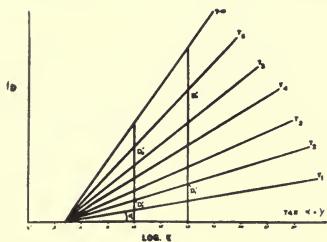

Fig. 3

The density increases with development until a limit is reached, and on infinite development (for a non-fogging developer and emulsion) the uppermost curve is obtained. The laws relating to the growth of density with time are discussed in a later chapter. For the present it is sufficient to note that the development factor, γ , increases with time of develop-

ment to a limiting value, but that, for the case shown, the inertia point ($\log i$) does not change with time. Also, γ is independent of the exposure.

The so-called "law of constant density ratios" of Hurter and Driffeld is a necessary consequence of the above results. This is illustrated for the two exposures represented by $\log E = 0.9$ and $\log E = 1.2$.

$$\frac{D_2}{D_1} = \frac{D'_2}{D'_1}$$

That is, for the straight line region, the density increases proportionately with time of development.

More meaning may be attached to the constant γ . Over the straight line region the slope $\tan \alpha = \frac{dD}{d \log E} = \gamma$.

The rate of growth of density with exposure is interpreted photographically as the "contrast". γ may therefore be termed the contrast of the negative.

Although in the above case (Fig. 3) the inertia is constant with increasing time of development, this is not true when soluble bromides are present in the developer. Moreover, at the same degree of development (same development factor, γ) the plate curve is "shifted" from its normal position. These results are illustrated in Fig. 4. The straight line portions only are considered.

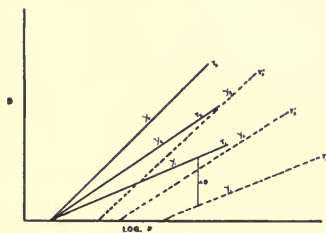

Fig. 4

Curves for the unbromided and bromided developers at three degrees of development are shown. This result was referred to by Hurter and Driffield and by Sheppard and Mees as a lateral shift of the plate curve, though the latter spoke of the "density depression" (ΔD in the figure), as the lowering of density produced by the bromide in plates at the same γ . They stated that the effect of inertia change or density depression wears off with time, so that finally the same inertia (same D) is reached as if no bromide were present. This conclusion has not been confirmed in the present work, the result being in some cases, however, obscured by the growth of fog.

Further, the amount of the shift of the curve (or the depression) produced by a given amount of bromide varies with the developer, it being greater for hydroquinone than for paraminophenol, for instance. Also, bromide is found to have a marked effect on the time required before development begins—the "time of appearance." This also varies noticeably with the developer. It is more or less evident, therefore, that developers differ in their "susceptibility" to bromide, and that their bromide sensitiveness is connected with their developing energies, as discussed above.

Sheppard's method of determining the relative reduction potentials of developers by means of the density depression with bromide may now be briefly outlined, though the calculation employed will not be clear until the velocity of development and the velocity constant have been considered. However, neglecting these for the time being, the method in general was to determine the depression for a definite degree of development with the developers to be studied, the depression-bromide concentration relation having been established for ferrous oxalate. The concentration of bromide necessary to produce the same depression at the same degree of development was then calculated for each developer. By comparing the concentrations of bromide thus found necessary to produce the same depression, the following values were obtained:

	Relative Reduction Potential
Ferrous oxalate.....	1.0
Hydroxylamine.....	1.13
Hydroquinone.....	0.5-0.7
Paraminophenol.....	3.4

Sheppard worked only over the range of bromide concentrations where practically the same γ is obtained in a given

time as if no bromide were used. The depressions under these conditions are small and the errors are proportionately large. Furthermore, this method cannot be used for all developers, as concentrations of bromide sufficient to cause much depression, require a much longer time to reach the same development factor with some developers than with others.

Though the fundamental basis for the method, as stated above, was not well established, the measurements undoubtedly show the relative shifts of the equilibrium points, and accordingly place the developers in the right order.

II. NEW CONCEPTIONS INTRODUCED IN THE PRESENT INVESTIGATION.

In the present work the effect of bromide on development was investigated and as a result some modifications in the above theory have been made. A new method of interpreting the depression data has been adopted. This revised theory is based on a study of about 25,000 sensitometric strips, representing all types of emulsions and a much wider range in developers, bromide concentrations, etc., than previously used. The general conclusions reached, relative to the bromide depression method, are explained below. The experimental results supporting the method, and obtained by means of it, constitute the second and third chapters of this monograph, and the effects of bromide on the velocity are considered in later chapters.

It was found that with all normal plates and normal unbromided developers the straight line portions of the H. and D. curves for varying times meet in a point on the log E axis for the entire range of times where fog is not produced to any great extent. (Excessive fog is usually considered as being greater in density than 0.5 or more.) This is the condition represented by Fig. 3. Consequently log i or the inertia point is independent of the time of development. Hurter and Driffield and also Sheppard and Mees found this to be true and stated it as a rule, though with scarcely sufficient proof.

It will be easier to ascertain whether or not the curves meet in a point by applying the theory about to be described than by actually extending the lines of all the curves. Moreover, the personal error is greatly lessened, because at low gammas the intersection point, or log i value, can be varied

greatly for only a small change in gamma. Also the new method is of more value in studying the whole subject of development.

The equation for the straight line portion of the curve, as previously stated is

$$D = \gamma (\log E - \log i) \quad (1)$$

If for a fixed value of $\log E$ ($\log E = \text{constant}$) we plot D against γ for each separate time of development (different values of γ) we shall obtain a straight line through the origin ($D = 0, \gamma = 0$) if $\log i$ is a constant, because the equation for each curve is

$$\begin{aligned} D &= \gamma \theta, \\ \text{where } \theta &= \log E - \log i = \text{constant.} \end{aligned} \quad (2)$$

That is, the rate of variation of density with gamma, $\frac{dD}{d\gamma}$ is θ and the density-gamma function is one of constant slope — i. e., a straight line.

The results of several hundred examinations were plotted (D against γ for a given exposure) and in many cases the data were least-squared to make sure of the lines passing through the origin. In this way the method was well established for the normal case.

Next, data for bromided development were examined and plotted in the same manner to determine the character of the D - γ curves. These were straight lines also, but generally they did not pass through the origin, having a positive intercept on the γ axis. This fact led to the formulation of more general conceptions.

Let us assume any system of straight lines (representing the H. and D. curves) of varying slope, intersecting in any point on the $\log E$ axis or below it, which correspond to plates developed for different times and therefore to different gammas. The coördinates of the point of intersection are a and b , where a is the abscissa expressed in units of $\log E$, and b the ordinate expressed in units of density. It is convenient to use a $\log E$ scale of relative values so that a is always positive. b is always negative or zero. From the system of curves the following equation can be written to express density at fixed exposure in terms of the coördinates of the point of intersection:

$$\begin{aligned} \frac{D - b}{\log E - a} &= \gamma, \\ \text{or } D &= \gamma (\log E - a) + b. \quad (\text{See Fig. 5.}) \end{aligned} \quad (3)$$

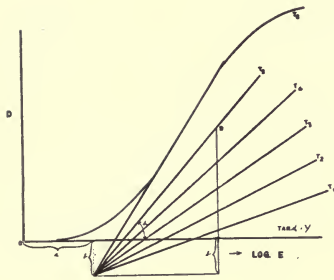

Fig. 5

(D, γ) and A the intercept on the gamma axis. By comparing equations 3 and 4

$$\theta = \log E - a, \text{ and} \tag{5}$$

$$b = -A \theta. \tag{6}$$

Equation 4 describes a density-gamma straight line of slope θ and intercept A on the γ axis. This is exactly what was observed in cases of bromided development. It is clear from mathematical considerations that when this condition obtains, the straight lines of the $H.$ and $D.$ curves must meet in a point. The coördinates of this point are derived from experimental data by the relations above. D is plotted against γ , giving a straight line of slope θ and intercept A .

$\log E$, the standard or fixed exposure chosen, is known. Hence a , from equation 5, is known, since

$$a = \log E - \theta. \tag{7}$$

b is determined by equation 6.

Other relations may be determined from those now available. For example, the gamma-log i relation was studied prior to the adoption of the present method and found to be in most cases a hyperbola, but errors in the measurement of gamma at high and low values obscured the result. The present interpretation clears up the matter. It can be shown graphically that

$$\frac{-b}{\log i - a} = \gamma \tag{8}$$

This is a rectangular hyperbola referred to the axes $\gamma = 0$ and $\log i = a$, a fact which is significant in connection with bromided development, where $\log i$ exhibits considerable variation.

To illustrate further: from equation 4, $D = \theta \gamma - A \theta$. Then if $A = 0$, $D = \theta \gamma$, or $D = \gamma (\log E - a)$ and $-A \theta = b = 0$. Hence if the D- γ straight line passes through the origin ($A = 0$), $b = 0$, and the lines meet in a point on the $\log E$ axis. Then $a = \log i$ and $D = \gamma (\log E - \log i)$, (the original H. and D. equation), and again we have a description of the family of curves in Fig. 3.

The usefulness of the density-gamma curve as a criterion for this characteristic of the H. and D. curves cannot be questioned. By this means it has been established that not only do the curves for unbromided developers meet in a point and on the $\log E$ axis, but also that the curves for the bromided developer meet in a point of coördinates a and b .

Now let us consider the effect of bromide on the location of the intersection point. The experimental data examined show that over the range of bromide concentrations employed, the D- γ lines meet in a point which moves downward with increasing bromide concentration. It is thus seen that Sheppard's "density depression" may be interpreted as a downward shift of the intersection point. There is no logical reason for assuming that the H. and D. curve is shifted laterally.

A constancy of a and increase (negatively) of b indicate that the intersection points move directly downward with increase of bromide concentration. This can be seen by comparing the D- γ curves for the different concentrations of bromide. From equation 7, a is constant if the slope θ is constant, and, from equation 6, the growth of b (negatively) is shown by the growth of A , the intercept. This is corroborated by the experimental work, as will be shown.

Therefore we may proceed to formulate the relations for the density depression, d , as measured by the downward shift of the intersection points. This will be generalized in order to include possible variations. The various steps are shown to make the deduction clear. From Fig. 6,

$$d = WN = WT + TN;$$

$$\frac{WT}{TM} = \gamma; WT = (TM) \gamma = (a_2 - a_1) \gamma;$$

$$TN = -b_2 + b_1.$$

Hence, $d = -b_2 + b_1 + (a_2 - a_1) \gamma$.

If I be the standard (for zero concentration of potassium bromide) and the a and b values for zero concentration are called a_0 and b_0 , the density depression, d , is given by

$$d = -b + b_0 + (a - a_0). \quad (9)$$

But for the normal case $b_0 = 0$ and $a = a_0$. Hence the depression caused by the concentration of potassium bromide, C , is

$$d = -b, \tag{10}$$

and this is independent of γ .

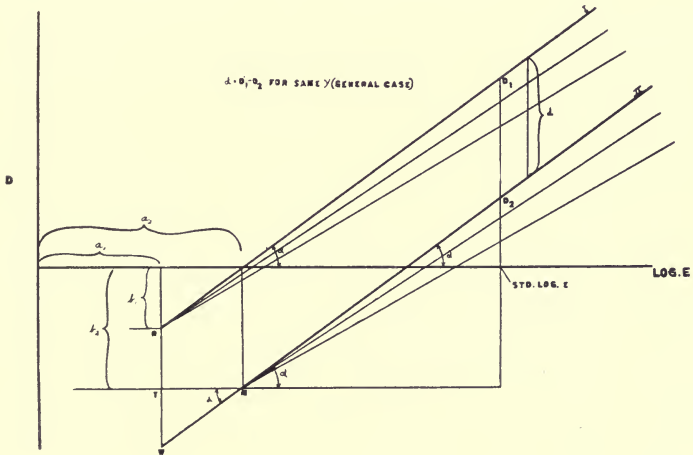

Fig. 6

This relation is supported by ample proof that for the average case a is independent of the bromide concentration (i. e., $a = a_0$) and that $b_0 = 0$. There are, of course, experimental deviations from this, but they represent relatively small accidental errors. Equation 10 is contradictory to numerous statements made by other investigators that "the effect of bromide wears off with time," and that the same inertia is obtained on prolonged development with bromide as without it. It will be shown that such statements are erroneous in so far as complete regression is concerned, and that although such results may be obtained at times, they are due mainly to the fog produced on prolonged development. These cases may be analyzed by the methods described here.

Having established a means of obtaining the density depressions produced in different developers by varying concentrations of bromide, it will be possible to inquire further into their meaning and to study the relation between the density depression and the concentration of bromide producing it.

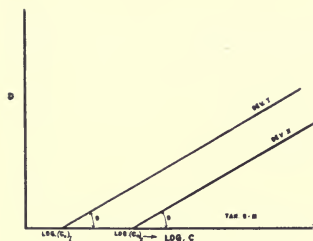

Fig. 7

Summarizing briefly, it is found that if the density depression, d , for any developer is plotted against the logarithms of the corresponding bromide concentrations, a straight line is obtained, like those shown in Fig. 7.

The equation for this curve is

$$d = m (\log C - \log C_0), \quad (11)$$

where m is the slope, and $\log C_0$ is the intercept on the $\log C$ axis. C_0 corresponds to the concentration of bromide which is just sufficient to cause a depression of density.

It is shown also that the d - $\log C$ lines for different developers have different intercepts (different values for $\log C_0$) but have practically the same slope, m . Thus two developers yield parallel lines, as shown in Fig. 7. Whether or not m is constant for all plates and all developers used could not be conclusively proved, but it was evident that in practically all cases tested it has very nearly the same value.

These facts are of importance in connection with the reduction-potential method. As stated above, C_0 is the concentration of bromide required to cause a perceptible shift of the intersection point. The comparison of the values of C_0 for two developers, therefore, gives a comparison of the reduction potentials if we assume that the change in the location of the intersection point measures the change in the amount of work done. Also, if m is constant, the rate of change of density depression with bromide concentration,

$\frac{dD}{d \log C}$, is constant and independent of the emulsion, of

the developer, and of the bromide concentration. The constant m may therefore be connected with fundamental laws relating to the development process.

These matters will be taken up again in connection with the experimental evidence, and in addition other relations of the bromide effect will be developed. The plan of outlining the propositions to be proved, or of stating many of the conclusions first, has been adopted because a large mass of photographic data presented without very clear aims would be quite confusing, and it is felt that in an investigation of this scope it would be equally unsatisfactory to develop all the steps of the theory along with the experimental evidence.

CHAPTER II

Developing Agents in Relation to their Relative Reduction Potentials and Photographic Properties (*Continued*)

EXPERIMENTAL DATA

The following terminology has been adopted in presenting the experimental data:

<i>D</i>	Density (proportional to mass of silver in given area);
<i>O</i>	Opacity;
<i>T</i>	Transmission;
<i>E</i>	Exposure;
<i>F</i>	Fog (density of fog under any conditions);
<i>t</i>	Time of development;
<i>t_a</i>	Observed time of appearance of a visible image during development (for standard exposure);
<i>a</i>	Log <i>E</i> coördinate of the point of intersection of straight line portions of the H. and D. curves;
<i>b</i>	Density coördinate for the same;
<i>a_o</i>	Value of <i>a</i> when no bromide is used (concentration of potassium bromide = 0);
<i>b_o</i>	Value of <i>b</i> when no bromide is used;
<i>C</i>	Concentration of bromide;
<i>C_o</i>	Concentration of bromide which causes the first perceptible depression of density (log <i>C</i> intercept of <i>d</i> -log <i>C</i> straight line);
<i>α</i>	Angle of inclination of H. and D. straight line with log <i>E</i> axis;
<i>γ</i>	Tan <i>α</i> development factor or contrast;
<i>θ</i>	Slope of density-gamma straight line;
<i>A</i>	Intercept of density—gamma straight line on <i>γ</i> axis;
<i>d</i>	Density depression = $D_1 - D_2$ (standard log <i>E</i>) at same <i>γ</i> for general case, $D_1 - D_2$ (independent of <i>γ</i>) = $-b$ for normal case of development in the presence of bromide;
<i>m</i>	Slope of <i>d</i> -log <i>C</i> straight line;
<i>π_{Br}</i>	Inverse bromide sensitiveness, or relative reduction potential by bromide depression method = $\frac{(C_o) x}{(C_o) \text{ standard}}$.

THE GENERAL EFFECT OF BROMIDE ON PLATE CURVES

The normal effect of increasing the concentration of bromide is shown in Fig. 8. Plates are developed with and without bromide, for varying times, producing different values of *γ*, and a complete series is obtained for no bromide and for each concentration of bromide used. After plotting the H. and D.

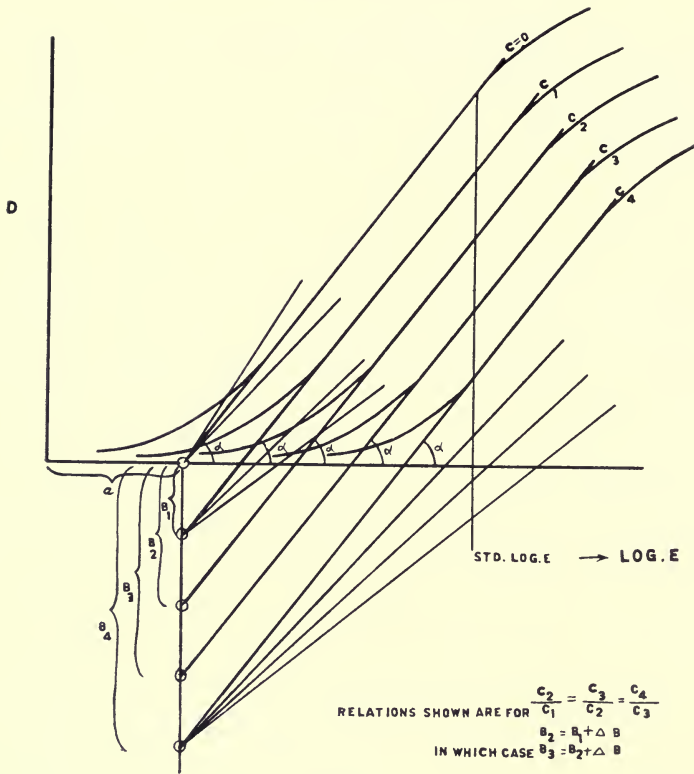

Fig. 8

curves, values of D at the standard exposure are plotted against the corresponding values of γ . This gives a D - γ straight line for each concentration, indicating that the straight lines of each set of plate curves meet in a point. The coordinates of the point of intersection, a and b , are determined as outlined above. The effect of bromide is then found to be that indicated by the figure, the intersection point undergoing a displacement downward along a vertical line. There may be deviations right and left in the value of a , but these are usually small. The general relations are as follows:

At $C = 0$ and $b_0 = 0$, for the unbromided developer the H. and D. curves intersect on the $\log E$ axis;

At the critical concentration, C_0 , the intersection point begins to move downward;

d , the density depression (for any concentration of potassium bromide) = $-b$, or the lowering of the intersection point;
 b is therefore a function of the bromide concentration

$$-b = m (\log C - \log C_0).$$

Consequently, over a range of concentrations, b increases (negatively) by the constant Δb if the concentration is increased by the same proportion each time; that is,

$$b_2 = b_1 + \Delta b$$

$$b_3 = b_2 + \Delta b$$

$$b_4 = b_3 + \Delta b, \text{ etc., if}$$

$$\frac{C_2}{C_1} = \frac{C_3}{C_2} = \frac{C_4}{C_3} \text{ etc.}$$

EXPERIMENTAL PROOF OF THE COMMON INTERSECTION

So much of the data can be clearly presented only by reproducing the curves obtained (tables of data would convey little meaning) that it is impossible to give as much as desired. An attempt has been made to avoid choosing, consciously or otherwise, only those cases giving nearly ideal results. By no means all the results obtained are as good as those shown, but the conclusions throughout are based on the general average of many examinations.

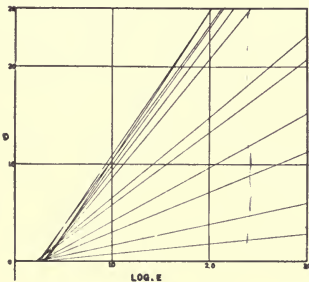

Fig. 9

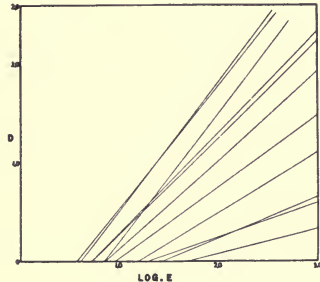

Fig. 10

Fig. 9 shows a set of H. and D. straight lines copied from the original curves. The times of development vary from 20 seconds to 20 minutes. Seed 23 emulsion on patent plate glass was used. The developer was M/20 paraphenyglycine. (For concentration of sulphite and alkali and other experimental details see Chapter I.) Development was carried out without bromide at 20° C. These curves illustrate the intersection point for unbromided development.

Fig. 10 gives the results for the same emulsion under similar conditions, but with M/20 paraminophenol hydrochloride and 0.04 M. potassium bromide. This result is not so good as many obtained.

It is unnecessary to consider the H. and D. curves themselves, for it has been shown that the best criterion for the existence of the common intersection point is the relation between density and gamma. If the latter represents a straight line function the curves meet in a point. Accordingly we shall examine some representative D- γ curves.

If the D- γ curve for the results shown in Fig. 9 is plotted, we get the straight line in Fig. 11. The fact that this is a

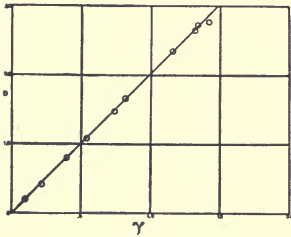

Fig. 11

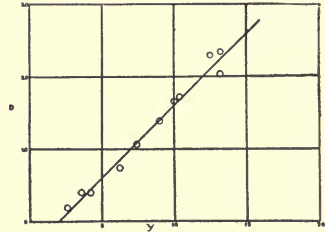

Fig. 12

straight line indicates that the lines meet in a point, and the fact that it passes through the origin shows that the lines meet on the log E axis. That is, in accordance with what has been said, if the intercept A on the γ axis is equal to zero, $b = 0$.

Plotting the data from Fig. 10 in the same way gives the line of Fig. 12. Here the points of the D- γ relation are not in so straight a line. Least-squaring the data for both slope and intercept gives the line shown. A has a positive value. Since $b = -A \theta$ (equation 4), b has a real value, indicating, as shown in Fig. 10, that the H. and D. straight lines meet in a point below the log E axis.

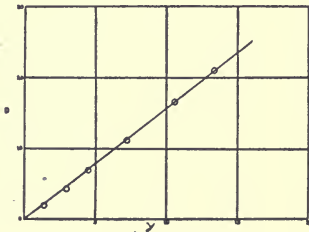

Fig. 13-A

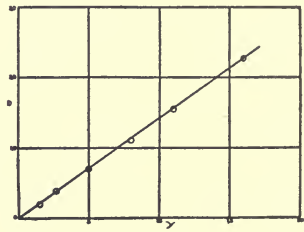

Fig. 13-B

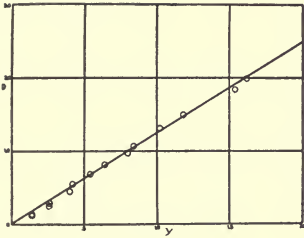

Fig. 13-C

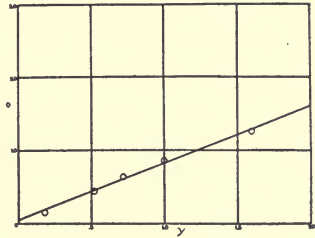

Fig. 13-D

Other examples are shown in Figs. 13 and 14.

Fig. 13 represents cases of normal development with no bromide present. Fig. 13a gives results of M/20 paraminophenol on Pure Bromide Emulsion I¹, Fig. 13b, of M/20 chlorhydroquinone on Pure Bromide Emulsion I; Fig. 13c, of M/20 paraphenyglycine on Pure Bromide Emulsion II¹, Fig. 13d, of M/20 paraminophenol on Seed Process Emulsion.

All examples shown in Fig. 14 have the same log E.

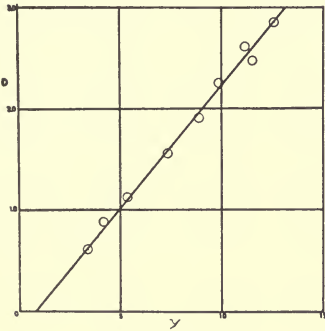

Fig. 14-A

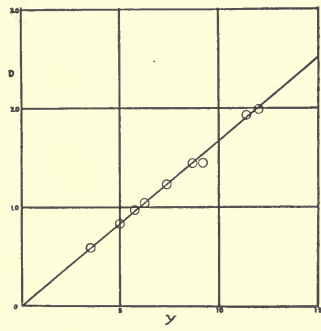

Fig. 14-B

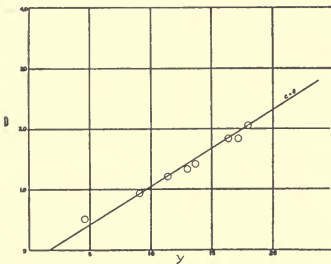

Fig. 14-C

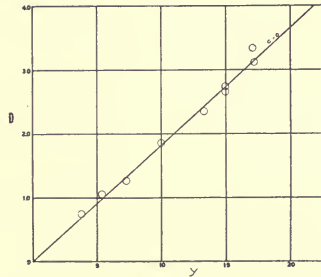

Fig. 14-D

¹ Special experimental emulsions made in the laboratory and containing only bromide of silver as the sensitive salt.

Fig. 14*a*, M/20 paraminophenol on Special Emulsion XII, no bromide in developer; Fig. 14*b*, M/20 paraminophenol on Special Emulsion X, no bromide in developer; Fig. 14*c*, M/20 paraminophenol on Special Emulsion XIII, no bromide in developer; Fig. 14*d*, M/20 paraminophenol on Special Emulsion XI, no bromide in developer.

Fig. 14*a* illustrates a special case in which, because of an emulsion effect which can be explained in accordance with present conceptions, the D- γ line usually does not pass through the origin. That is, the H. and D. curves meet below the log E axis when no bromide is used in the developer.

Many other illustrations could be given, but the above are sufficient. Though some experiments were not conclusive, there were no cases of normal development in which any other systematic condition existed.

DATA ON THE EFFECT OF BROMIDE ON THE INTERSECTION POINT

Density-gamma curves were plotted for many developers used on different emulsions with varying concentrations of bromide. In general, these results were in accord with those illustrated here. As required by the theory outlined, θ , the slope of the D- γ line, is constant, and independent of the bromide concentration. From equation 3, $a = \log E - \theta$. Since $\log E$ is constant (unless otherwise stated), a constancy of θ indicates a constancy of a . That is, the intersection point moves directly downward as b increases.

To prove this, the data from the D- γ relation were least-squared for slope and intercept where the straight lines could not be drawn by inspection.

Fig. 15 shows the curves for M/20 paraminophenol on Special Pure Bromide Emulsion I, with various concentrations of bromide. The slope of the straight lines is nearly the same, even at the highest concentration.

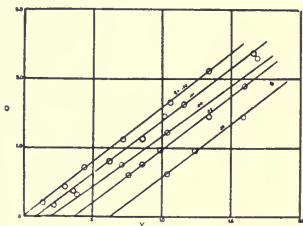

D- γ curves for KBr concentrations 0, .01, .04, .08 and .32 M.

Fig. 15

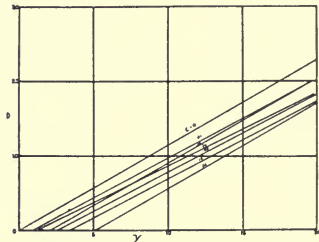

D- γ Curves for KBr concentrations 0, .01, .02, .04, .08, .16 and .32 M.

Fig. 16

Fig. 16 gives the $D-\gamma$ straight lines (obtained by least-squaring the data), for M/25 bromhydroquinone on Special Pure Bromide Emulsion II. The various points are not indicated because the curves are so close together that the many points would be confusing.

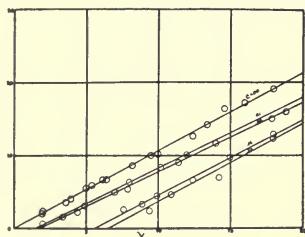

Fig. 17

The curves in Fig. 17, for M/20 chlorhydroquinone on Special Pure Bromide Emulsion II, are not so good as those generally obtained. The curves for .01 and .02 M potassium bromide, and for 0.16 and 0.32 M, lie nearer each other than they should.

Space does not permit detailing more of these individual cases. However, one very complete experiment is described to illustrate the method, which fulfills all present requirements. This experiment was performed with M/20 dimethylparaminophenol sulphate on Seed 30 emulsion coated on patent plate glass. The range of concentrations of bromide was from 0.01 to 0.64 M. The data were interpreted as follows: The $D-\gamma$ data were plotted for each concentration, and the observations least-squared for slope and intercept. The average slope for all the curves was then obtained, and the observations again least-squared to the average slope for the value of the intercept A . This is justifiable since a great deal of experimental data has indicated that the slope is practically constant. The curves in Fig. 18 show how well the observations bear out the conclusions, and what deviations there are from the common slope. As may be seen, deviations are relatively small. The standard value of $\log E$ used was 3.00 (logs to base 10 of relative exposures). The average slope, θ , was 2.78. Hence $a = \log E - \theta$, or $a = 3.00 - 2.78 = 0.22$ for all cases. The value of A may be seen from the curves for each concentration; and it will be remembered that $b = -A\theta$.

Analysis of all available data has shown that the normal effect of bromide on the plate curves (H. and D. curves) is a downward displacement of the intersection point.

Having now proved the existence of the common intersection and its behavior with bromide, we may proceed to a study of the bromide depression and its applications.

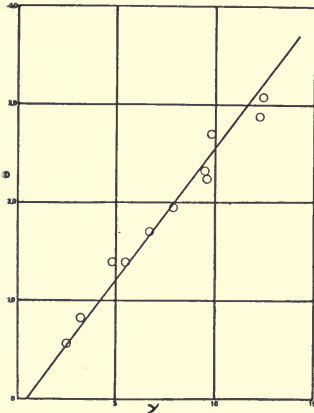

C=0
Fig. 18-A

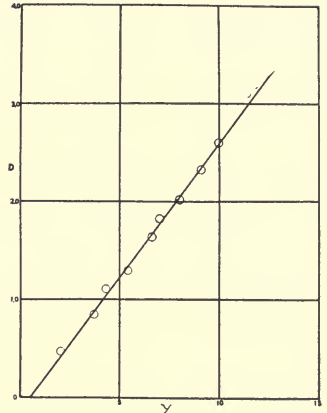

C=.01
Fig. 18-B

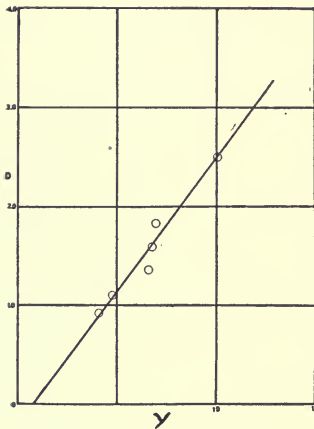

C=.02
Fig. 18-C

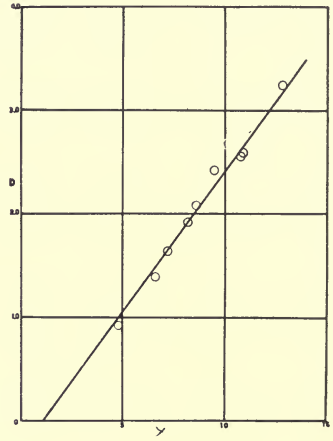

C=.04
Fig. 18-D

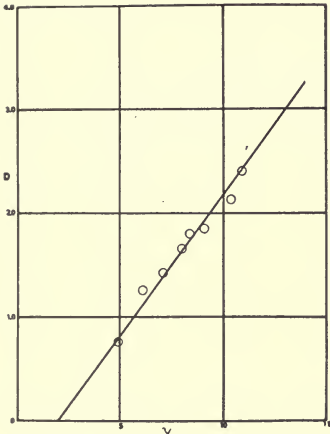

$C=.08$

Fig. 18-E

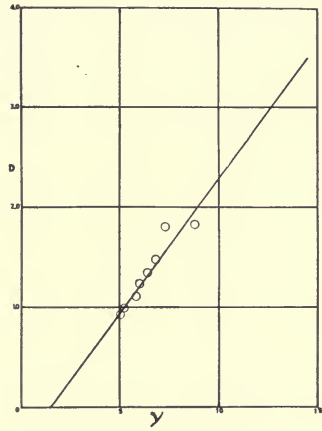

$C=.16$

Fig. 18-F

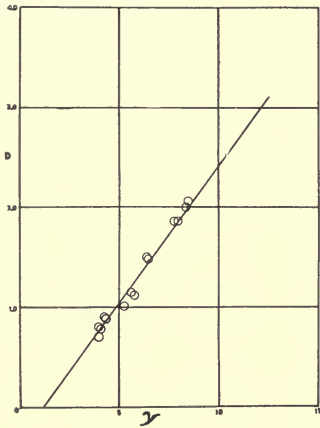

$C=.32$

Fig. 18-G

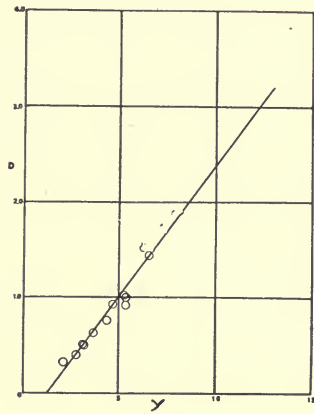

$C=.64$

Fig. 18-H

THE EVALUATION OF THE DENSITY DEPRESSION

The density depression, d , may be expressed most conveniently in terms of the coördinates of the points of intersection and their relative shift due to the bromide (equation 9, Chapter I)

$$d = -b + b_0 + (a - a_0) \gamma,$$

where a and b are the coördinates for the bromide concentration C , and a_0 and b_0 their values when no bromide is used. This is the general equation which includes corrections for deviations from the ideal case in which $a = a_0$, $b_0 = 0$, the depression $d = -b$, and d is therefore independent of γ .

Table 3 gives an analysis of least-squared density-gamma data from earlier experiments on Seed 23 emulsion (patent plate). These data are much less perfect than those from

TABLE 3
Seed 23 Emulsion of May, 1917
Analysis of Least-squared Density-gamma Data

Developer	KBr						
	C	$\log E$	θ	A	a	b	d
$\frac{M}{20}$ Chlorhydroquinone	0	2.30	1.82	0	.48	0	0
Experiment 14	.01M		2.30	.21	.00	-.48	.00
	.02		2.25	.29	.05	-.68	.22
	.04		2.15	.30	.15	-.65	.32
	.08		2.64	.52	-.34	-1.37	.55
	.16		2.20	.48	.10	-1.05	.67
	.32		2.06	.50	.24	-1.03	.79
$\frac{M}{20}$ Monomethyl par-aminophenol sulphate	0	2.10	1.62	.05	.48	-.08	0
	.01		1.53	.09	.57	-.14	.15
	.04		1.82	.16	.28	-.29	.00
	.08		1.42	.14	.68	-.20	.32
	.16		1.36	.15	.74	-.20	.38
	.32		1.23	.15	.87	-.19	.50
	.64		1.33	.20	.77	-.27	.48
$\frac{M}{20}$ Paraminophenol hydrochloride	0	2.40	1.98	.06	.42	-.12	0
	.01		1.74	.06	.66	-.10	.20
	.02		2.00	.13	.40	-.26	.12
	.04		2.00	.20	.40	-.40	.26
	.07		2.08	.29	.32	-.60	.38
	.10		1.67	.23	.73	-.38	.57
	.20		3.10	.43	-.70	-1.33	.09
	.40	data of insufficient range.					
$\frac{M}{20}$ Hydroquinone	0	2.40	2.24	.06	-.16	-.12	0
	.005		2.36	.15	.04	-.35	.11
	.01		2.45	.28	-.05	-.69	.36
	.02		2.42	.34	-.02	-.81	.51
	.04		2.04	.32	.36	-.65	.73
	.10		2.50	.60	-.10	-1.50	1.12

later more complete work. Different values of $\log E$ were used because the straight line range of the plate-curve was not great enough to provide for the varying conditions which were obtained, and it was desirable to use values of D which lay within the straight line portion in all cases.

The deviations in θ , and consequently in a , are greater than desirable, and irregular. The density depression, d , in the last column is computed from equation 9, the formula repeated above, where the value 1.0 is taken for γ . Although b_0 is not equal to 0 in each of these cases, a general trend in that direction is indicated.

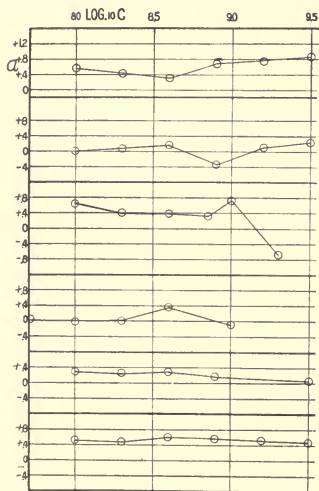

Fig. 19

Before proceeding with the determination of the density depression, let us examine more closely the relations for the constant a . In Fig. 19, a (as measured from the D - γ curves) is plotted against the logarithm of the bromide concentration for several average cases. These and other results show that the total deviation of a is relatively small. It is not necessary to discuss here at greater length the fact that over a wide range a is independent of the bromide concentration and a constant for the given plate and developer. Accordingly the density depression is found by means of the simple relation $d = -b$ (b

is considered negative, d positive). The use of the constant a and the method outlined in determining plate speeds will be discussed in the next chapter.

RELATION OF THE DENSITY DEPRESSION TO THE BROMIDE CONCENTRATION AND THE DEPRESSIONS WITH DIFFERENT DEVELOPERS

If the density depression, d , is plotted against the logarithms of the corresponding bromide concentrations, a straight line is obtained, as indicated in Chapter I. The equation for this line may be written

$$d = m (\log C - \log C_0),$$

m being the slope and $\log C_0$ the intercept on the $\log C$ axis, as explained above. (See Fig. 14.)

Typical experimental results are given in the following figures. Fig. 20A gives the results obtained with M/10 ferrous oxalate on Seed 23 emulsion. Fig. 20B represents the depressions for M/20 paraphenyglycine on Seed 30 emulsion.

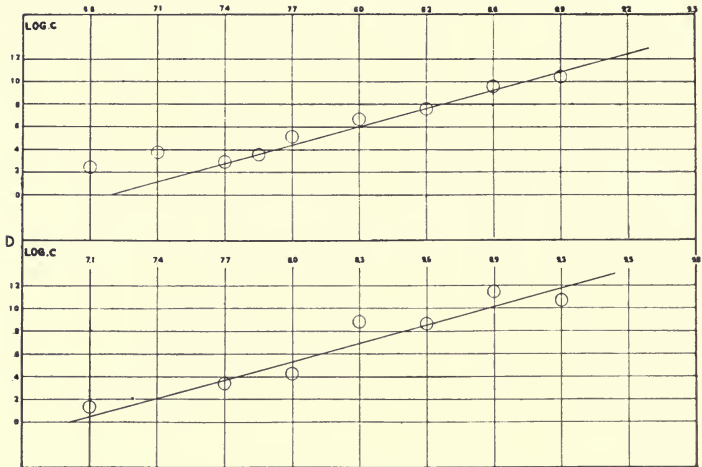

Figs. 20-A and B

Not only these, but practically all the curves obtained have very nearly the same slope, m . The general method of treatment of the data is therefore like that of the $D-\gamma$ curves. The $d\text{-log } C$ curves were obtained for each emulsion with all the developers used on that emulsion, and least-squared (where necessary) for slope and intercept. The slopes, which were very similar, were averaged, and the data again least-squared to the common slope for the intercept $\log C_0$. It will be seen that in some cases there are not many observations, but it must be remembered that each point on the curves represents much experimental work, sometimes as many as fifty or sixty plates, and it was impossible at the time when some of this work was begun to foresee that so much material would be necessary. In some cases, therefore, we ran short of the particular batch of emulsion or developer needed. The deviation of observations based on so many plates can scarcely be explained, but they are in accord with general experience in photographic work. Fig. 21 gives data for different developers on Seed 23 emulsion. The lines represent the result of least-squaring to the common slope, $m = 0.43$.

Fig. 22 illustrates similar results with Pure Bromide Emulsion I.

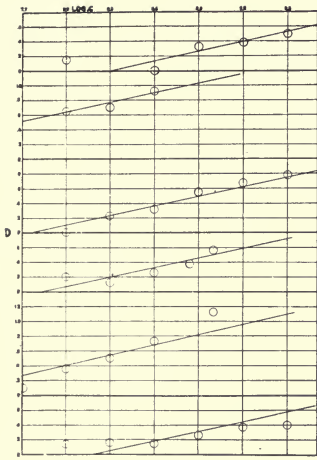

Fig. 21

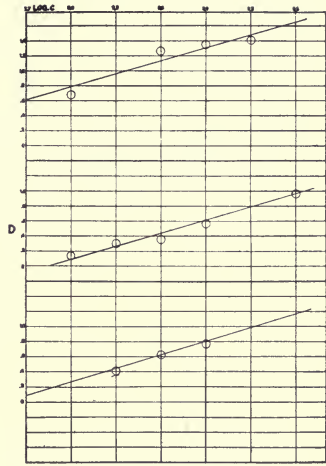

Fig. 22

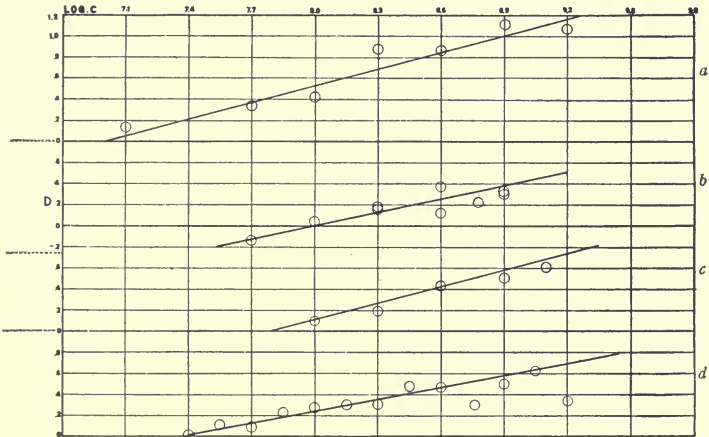

Fig. 23

In Fig. 23 are shown the depressions for four developers used on Seed 30 emulsion. In the second of these experiments, at high concentrations of bromide, represented by Fig. 23*b*, there is a departure from the relations thus far described. This is also shown, though to a less extent, by dimethylparaminophenol, in Fig. 23*c*, and was noticed in other cases. The phenomena may be due to a change in the photometric constant, (ratio between density and mass of silver per unit area) or to some specific action of the bromide, a possibility discussed later, or, more probably, to both.

CHAPTER III

Developing Agents in Relation to their Relative Reduction Potentials and Photographic Properties (*Continued*)

THE RELATIONS FOR THE SLOPE OF THE DENSITY DEPRESSION CURVES

The comparison of the values of C_0 for different developers will be a logical method only if the slope m of the density-depression curves is constant. The evidence we have for this is shown in Table 4. Some later work has shown the rate of change of depression of the maximum density or equilibrium value with bromide concentration to be the same (i. e., the depression in maximum density expressed as a function of the bromide concentration has the same slope), so that very probably it is correct to assume the slope constant.

The data in Table 4 were least-squared for slope and intercept except where otherwise noted.

TABLE 4

EMULSION	DEVELOPER	<i>m</i>
Seed 23 of May, 1917 ..	Bromhydroquinone.....	.20
	Monomethylparaminophenol sulphate.....	.28
	Toluhydroquinone.....	.52
	Paraminophenol hydrochloride.....	.36
	Chlorhydroquinone.....	.50
	Hydroquinone.....	.80
	Average.....	.44
Pure Bromide I.....	Hydroquinone.....	.64
	Paraminophenol hydrochloride.....	.54
	Chlorhydroquinone.....	.56
	Average.....	.58
Pure Bromide II.....	Bromhydroquinone.....	.28
	Chlorhydroquinone.....	.38
	Paraphenyglycine.....	.70
	Average.....	.45
Seed 23 of June, 1919..	Ferrous oxalate.....	.54
	Hydroquinone.....	.98
	Paraphenyglycine.....	.87 ¹
Seed 30 of July, 1919 ² ..	Paraphenyglycine.....	.54
	Pyrogallol.....	.42
	Dimethylparaminophenol sulphate.....	.46
	Paraminophenol hydrochloride.....	.40
	Average.....	.46

¹ Only four depression values were obtained here, therefore the data were not least squared.

² Most complete data secured.

The values in Table 4 are of wide range for averaging. The conclusion that the slope is practically constant was reached by weighing this and later analogous data, the relative values of which cannot be indicated in the present table. In the earlier work the deviations were large because but few different concentrations of bromide were employed. For the most complete data (widest range and greatest number of bromide concentrations, and data therefore of most weight) such as the last series of table 4, the values were much more consistent. The averages for the other series of the table are partly accidental.

There is a possibility, however, that hydroquinone is an exception to the rule, as it persistently shows a higher slope. This developer was found to be somewhat unusual in other respects, possibly because of the easy regeneration of the developing agent from its oxidation products by the action of the other constituents—a question to be discussed later. But until there is proof to the contrary, it will be assumed that the slope of the density depression-bromide concentration function is constant.

It is found also that the slope m is independent of the emulsion and of the developer used. This is, therefore, one of the more fundamental constants, and probably indicates an important fact which will be used as a general law, for the present at least.

Since m is constant—that is, the rate of change of depression with bromide concentration is independent of emulsion, developer, and bromide concentration—a method for determining the relative bromide sensitiveness of any developer may be formulated. For any two developers, a comparison of the $\log C$ values at which the same depression is produced will yield the same results as a comparison of the intercepts ($\log C_0$). Hence, the concentrations of bromide required to produce the same depression or the same change in the amount of work done by any two reducing agents, used under conditions described above, may be computed. As stated above, this method is analogous to comparisons of physical forces, since the resistances required to cause the same change in the amount of work done have been measured. It may be assumed that these give a measure of the relative chemical potentials of any two developers, though, as previously stated, this is not necessarily a true indicator of the relative chemical potentials of the isolated reducing agents. Also, further work will be required to establish the quantitative relations connecting this method with the chemical theory.

However, as already stated, additional evidence in favor of this method (see Chapter VI) shows that the rate of displacement of the equilibrium is the same as that measured here, and comparisons made on that basis place developers in the same order. Consequently it is felt that this method will eventually be established as fundamentally correct.

THE VARIATION OF C_o WITH THE EMULSION USED

Although m has been found to be independent of the emulsion employed, this is apparently not true of C_o , the value of the concentration of bromide required for initial depression. This is unfortunate, as it necessitates the use of one developer as a standard each time a different emulsion is used, which means a laborious re-determination of the density-depression curve for a developer with which other comparisons have been made. The values of C_o for a given developer on different emulsions are usually of the same order, but the deviations are so great that we must conclude for the present that the emulsion influences the result. Table 5 gives the data available.

TABLE 5
Values of C_o (in units of 4th decimal place, i. e. $\times 10^4$)

DEVELOPER	EMULSIONS USED				
	Seed 23 May, 1917	Pure AgBr I	Pure AgBr II	Seed 23 June, 1919	Seed 30 July, 1919
Hydroquinone.....	10	4.4	20
Paraminophenol hydro- chloride.....	69	72.5	25
Paraphenyglycine.....	3.4	11.8	42	10
Chlorhydroquinone.....	59	35.5	40.8
Bromhydroquinone.....	155	186.0

If the values of C_o vary with the emulsion, this constant may be of some importance in expressing the characteristics of the plate. However, the difficulty of determining it would prohibit its practical use.

THE VARIATION OF C_o WITH THE DEVELOPER. RELATIVE REDUCTION POTENTIAL, π_{Br}

The greater the value of C_o , the lower the bromide sensitivity of the developer. Hence, we may say that

$$\text{Bromide sensitiveness} \propto \frac{1}{C_o}.$$

But the greater the value of C_o the greater the reduction potential. Therefore,

$$\pi_{Br} = f(C_o), \text{ which is possibly } \pi_{Br} = k \log C_o.$$

But for the time being we arbitrarily define this as

$$\pi_{Br} = k C_o.$$

At present there is no means for determining this constant k . As stated above, it is impossible with our present knowledge to measure the absolute chemical potential. The reduction potential of a developer X will be $(\pi_{Br})_x = k (C_o)_x$; that for a given standard developer will be $(\pi_{Br})_{Std.} = k (C_o)_{Std.}$. Consequently the relative reduction potential, π_{Br} , for any developer X referred to a given standard is

$$\pi_{Br} = \frac{(\pi_{Br})_x}{(\pi_{Br})_{Std.}} = \frac{k (C_o)_x}{k (C_o)_{Std.}} = \frac{(C_o)_x}{(C_o)_{Std.}}.$$

This relation has been used for obtaining the new data by this method. The results are given in Table 6. Values of C_o are expressed in units of the fourth decimal place (molar concentrations of potassium bromide). π_{Br} is relative to the standard developer indicated. All values of π_{Br} are referred to M/20 hydroquinone as having a reduction potential of unity. It should be remembered that all the developers (except bromhydroquinone and ferrous oxalate, which were used in concentrations of M/25 and M/10, respectively), are twentieth molar, with 50 gm. sodium sulphite + 50 gm. sodium carbonate, per liter.

TABLE 6
Values C_o and π_{Br}

EMULSION	$\frac{C_o \cdot x \cdot 10^4}{(C_o)_{Std.}}$	$\pi_{Br} = \frac{(C_o)_x}{(C_o)_{Std.}}$
Seed 23 of May, 1917—		
Paraphenyglycine	3	0.3
Hydroquinone	10	1.0 Std.
Toluhydroquinone	25	2.5
Chlorhydroquinone	60	6.0
Paraminophenol hydrochloride	70	7.0
M/25 Bromhydroquinone	160	16.0
M/20 Monomethylparaminophenol sulphate	200	20.0
Pure Bromide I—		
Hydroquinone	4.4	1.0 Std.
Paraminophenol hydrochloride	73	16.5 Small amount of data
Chlorhydroquinone	36	8.1

Pure Bromide II—		
Paraphenyglycine	12	1.7
Chlorhydroquinone	41	6.0 (Assumed Std. and = 6.0 as on Seed 23)
M/25 Bromhydroquinone	186	26.8
Seed 23 of June, 1919—		
M/10 Ferrous oxalate	8	0.3
M/20 Hydroquinone	25	1.0 Std.
M/20 Paraphenyglycine	40	1.6
Seed 30 of July, 1919—Most complete data—		
Paraphenyglycine	10	1.6 Std.
Paraminophenol hydrochloride	25	5
Dimethylparaminophenol sulphate	60	10
Pyrogallol	100	16

A study of Table 6 shows that it is extremely difficult to reproduce actual numerical values of π_{Br} . For example, the following were obtained for paraminophenol used on three emulsions:

Seed 23 of May, 1917	7
Pure Bromide	16.5
Seed 30	5

Values for paraphenyglycine vary as follows:

Seed 23 of May, 1917	0.3
Pure Bromide II	1.7
Seed 23 June, 1919	1.6
Seed 30 July, 1919	1.6

However, with the one exception of paraphenyglycine on Seed 23 emulsion of May, 1917, the developers always fall in the same order. We, therefore, weigh the data as fairly as possible, and adopt the result as the best we can, with no great claims for accuracy. With paraphenyglycine, for instance, the value 0.3 is obtained with only three concentrations. The data for the other emulsions, especially for the last, are more complete. The evidence in any case is three to one in favor of the higher value. Proceeding in this manner we can construct a table of what we consider to be the fairest approximations to the relative reduction potentials. This table, including some of the results of previous work, is given below.

TABLE 7

	π_{Br}
Hydroquinone	1.0
Paraphenyglycine	1.6
Tolhydroquinone	2.2
Paraminophenol	6
Chlorhydroquinone	7
Dimethylparaminophenol	10
Pyrogallol	16
Monomethylparaminophenol	20
Bromhydroquinone	21
Methylparamino-orthocresol	23

PREVIOUS RESULTS

Measurements of reduction potentials made prior to those recorded above are given in Table 8.

TABLE 8

REDUCTION POTENTIAL VALUES

From Work done Prior to 1917

	π_{Br}
Sheppard (Photographic Method)—	
M/10 Hydroquinone (caustic).....	1.0
M/10 Ferrous oxalate.....	1.8
M/10 Hydroxylamine hydrochloride.....	2.0
M/10 Paraminophenol hydrochloride (caustic).....	5.4
Frary and Nietz (Electrometric Method)—	
Hydroquinone (Sod. carb.).....	1.0
Mixture of hydroquinone and monomethylparaminophenol sulphate.....	2.7
Diamidophenol.....	36.0
Thiocarbamide.....	53.0
Nietz (Preliminary work, this laboratory) (Photographic Method)—	
M/20 Paraphenyglycine.....	0.7
M/20 Hydroquinone.....	1.0
M/20 Chlorhydroquinone.....	1.4
M/20 Toluhydroquinone.....	1.8
M/20 Paraminophenol.....	2.7
M/20 Monomethylparaminophenol.....	7 to 16
M/20 Paraphenylene diamine—no alkali.....	0.3
M/20 Paraphenylene diamine—with alkali.....	0.4
M/20 Methylparaphenylene diamine—no alkali.....	0.7
M/20 Methylparaphenylene diamine—with alkali.....	3.5
M/20 Methylparamino-orthocresol.....	23
M/20 Paramino-orthocresol.....	7

Sheppard's results, recomputed to a basis of hydroquinone = 1.0, were corrected for the reduction equivalent, or "reducing power." Sheppard found, as did also the writer, that hydroquinone had certain marked characteristics, not yielding, by the former's method, a constant value for the relative reduction potential. The joint work of Frary and the writer was of a preliminary nature, and was unfortunately not carried out with standard concentrations of the developers. But the values obtained are apparently in the proper order and useful as an indication of the relations.

The values given in the third section of the table were obtained by the writer by the use of Sheppard's method. These are not as accurate as later work, but again the results are in the same order.

AN ENERGY SCALE OF DEVELOPERS

As a result of the measurements recorded here, we may now state the general order, on a scale of developing energy, of a number of developers. Including the averaged and weighted results obtained from Table 6, and the general results from Table 7, we may write this "scale of developers" as in Table 9.

TABLE 9

	π_{Br}
M/10 Ferrous oxalate	0.3
- M/20 Paraphenylene diamine hydrochloride, no alkali	0.3
M/20 Paraphenylene diamine hydrochloride, plus alkali	0.4
M/20 Methylparaphenylene diamine hydrochloride, no alkali	0.7
- M/20 Hydroquinone	1.0
- M/20 Paraphenyglycine	1.6
M/10 Hydroxylamine hydrochloride	2.0
M/20 Toluhydroquinone	2.2
M/20 Methylparaphenylene diamine hydrochloride, plus alkali	3.5
- M/20 Paraminophenol hydrochloride	6.0
M/20 Chlorhydroquinone	7.0
M/20 Paramino-orthocresol	7.0
- M/20 Dimethylparaminophenol sulphate	10.0
M/20 Pyrogallol	16.0
- M/20 Monomethylparaminophenol sulphate	20.0
M/25 Bromhydroquinone	21.0
M/20 Methylparamino-orthocresol	23.0
M/20 Diaminophenol	30 to 40
M/20 Thiocarbamide	50.0

Further information on reduction potentials is obtained by the application, made later, of the study of the velocity curves and the final or equilibrium value for the density. A discussion of reduction potential and its relation to photographic properties and to the chemical constitution of the developing agent is necessarily deferred until the collected results are given.

CHAPTER IV

A Method of Determining the Speed of Emulsions and Some Factors Influencing Speed

The so-called "speed" of a photographic emulsion is a subject which has played a most important part in the history of photography. In fact we may almost say that it has been largely responsible for the scientific development of photography, since some of the most important researches in which the principles of chemistry, physics and mathematics have been applied grew out of an endeavor to obtain measurements of plate speeds. This is particularly true of the well-known work of Hurter and Driffield. Many controversies arose following the appearance of Hurter and Driffield's first paper, many of the discussions centering around the determination of emulsion speed. Investigation of the subject is still being actively pursued by workers in the field of sensitometry.

Special mention is made of the subject here because of its historical importance and because it is hoped that the data made available by the present work may be of use in studying the many unsolved questions related to emulsion speed.

IMPORTANCE OF THE METHOD OF EXPOSURE

It is to be noted especially that while most of the principles already stated may be applied to a study of photographic development irrespective of how the exposures are made (so long as they are made always in the same way), it now becomes necessary to take into account the method of exposure. Because of the failure of the plate to integrate properly intermittent exposures, and the failure of the so-called "reciprocity law" ($E = It$), both of which may be different for different emulsions, and even for different batches of the same emulsion, the comparison of two emulsions for the exposures required to give a definite result involves considerable care and knowledge. The questions of intermittency effect and reciprocity failure are under investigation. The general results have shown that a non-intermittent exposure on a time scale with proper adjustment between intensity and time, or, better still, exposure on an intensity scale with a proper value for the intensity, is required. An intermittent (rotating sector-wheel) sensitometer will give results approaching those

of the non-intermittent instrument as the speed of revolution falls below a certain value and is gradually decreased to one revolution for the entire exposure. This fact should be borne in mind in comparing the relative speeds shown by two emulsions where the exposures are on an intensity scale and the time is relatively short.

DEFINITIONS AND SENSITOMETRIC CONCEPTIONS INVOLVED

It is obvious that according to any conception of speed, the shorter the exposure required to give a definite result, the greater the speed. If we term H the speed

$$H \propto \frac{1}{E} \text{ or } H = \frac{k}{E}.$$

It is evident that this "definite result" should be standardized as regards the method for obtaining the speed, the value of k , and the units in which to express E .

A clear conception of the meaning of emulsion speed was first presented by Hurter and Driffield. If any two plates are always developed (with any developer) to a normal contrast (as is often done in practice)—that is, to a standard value of γ —the relative speeds of the two plates are to each other inversely as the exposures corresponding to their inertia points. (Reference to the contrast is necessary if all cases are to be covered.) This is made somewhat clearer by consideration of Fig. 24 and the explanation following.

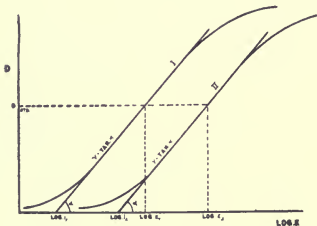

Fig. 24

If plates I and II are exposed in a sensitometer, developed to the same degree, and their densities measured and plotted against the logarithms of the corresponding exposures, curves having certain straight line portions, like I and II in Fig. 24, are obtained. If the straight lines are extended they cut the log E axis at $\log i_1$ and $\log i_2$, which are termed the inertia

points. Speed is interpreted as the measure obtained from values of the exposure required to give a definite density. Accordingly, choose any ordinary value of density lying in the "region of correct exposure" or straight line of the plate, such as $D_{Std.}$ in the figure. Projecting a line parallel to the log E axis from $D_{Std.}$ to curves I and II and from the intersections

vertically downward to the log E axis gives the points log E_1 and log E_2 . Logs E_1 and E_2 are, therefore, the exposures required to give the same density on plates I and II under these conditions. Therefore, according to the equation $H = \frac{k}{E}$, the speed of one emulsion compared with the other is given by

$$\frac{H_1}{H_2} = \frac{E_2}{E_1}.$$

But since I and II are parallel lines (plates at the same degree of development) the ratio $\frac{E_2}{E_1}$ is the same as $\frac{i_2}{i_1}$; or, the speed relations can be obtained from the values for the inertias. Hence we may write $\frac{H_1}{H_2} = \frac{i_2}{i_1}$. Further, if log i_1 and log i_2 remain constant with increasing development, then the ratio $\frac{i_2}{i_1}$ is not affected by development; that is, the speed is independent of γ .

Unfortunately, the inertia is not always independent of the degree of development, especially if bromide is used in the developer; and it is here that the results described in the preceding chapters may be applied.

We may get rid of comparisons and relative speed values by deciding in what units to express i and what value to assign to the constant k in the equation

$$H = \frac{k}{i} \text{ (by definition of absolute speed).} \quad (12)$$

Although E and i have always been measured in visual units, there is obviously no logic in such a procedure, since the visual measurement of light intensity is affected by limitations of the human eye quite different from those affecting the photographic emulsion. In other words, the photographic plate does not necessarily see two intensities in the same relation as does the human eye. However, until there has been put forward a satisfactory photographic light unit, we must continue to use the visual unit, E and i being expressed in candle-meter-seconds (or, as commonly written, c. m. s.).

Usually k is so evaluated as to give values of H in convenient numbers. The value $k = 34$ was selected by Hurter and Driffield, adjusted for use with their "Actinograph" or exposure calculating scale.

All further considerations in this monograph avoid the use of absolute speed values in arbitrary units. We may proceed very satisfactorily by employing a relative exposure scale, this being convertible at any time by knowing the relation between the scale and the actual intensity-time measurements. For example, all exposures made during the course of this work, beginning in February, 1919, were such that $\log E = 2.4$ represents 1.4 candle-meter-seconds (visual) of acetylene screened with Wratten No. 79 filter to daylight quality. This fact furnishes the connecting link between the relative and absolute exposure values.

A NEW METHOD

The details of a somewhat different method for the determination of definite sensitometric constants expressing the speed of an emulsion have already been described. It is for the purpose of emphasizing this method in its affiliation to the whole subject of speed that it is taken up again. The writer also wishes to point out that the older method, as presented in the foregoing section, serves very well in ordinary cases where a good standard developer can be used on emulsions of the usual type. But in order to obtain a fair estimate of speed in practically every case, no matter what the emulsion or the developer, other conceptions are most emphatically necessary. Much of the controversy on the question has arisen from the erratic results obtained in certain cases.

It has been shown that the straight lines of the H . and D . curves for any case of normal development always have a common intersection. The coordinates of this point of intersection were termed a and b , and these are the sensitometric constants with which we are principally concerned here. a is the $\log E$ coordinate of this point and b the density coordinate. If $b = 0$, the curves intersect on the $\log E$ axis. This is the case for nearly every ordinary emulsion and every developer of the usual type which contains no bromide. But if emulsion or developer contain bromide, b has a real value and the intersection point lies below the $\log E$ axis. In consequence, $\log i$ changes with time of development and with contrast. Now a is not affected by bromide, and therefore can be determined with any concentration of bromide (over a wide range) in the developer. It has been assumed that for no bromide b will be zero. Exceptions to these rules are rare in the case of ordinary materials and can be explained either by the fog error or by a progressive secondary reaction

during development, which produces a shifting equilibrium point. Any case of general deposition of silver over the plate of course upsets the relations.

The application of the method to the most general case is illustrated in Fig. 25.

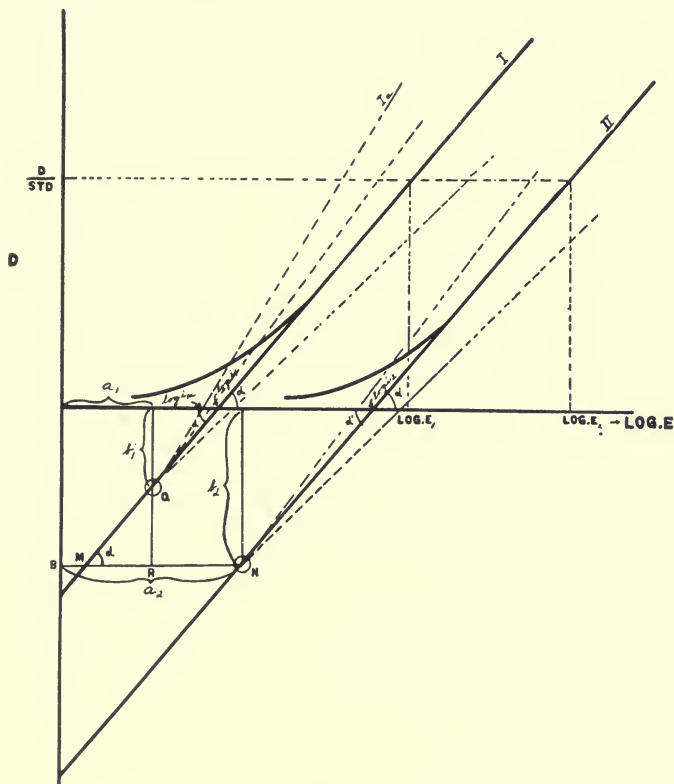

Fig. 25

Consider first a comparison in speed of two emulsions, I and II. Different times of development (under constant conditions) yield for emulsion I a family of H. and D. curves whose straight lines intersect in the point Q . Q has coördinates a_1 and b_1 , as shown. Similarly emulsion II gives curves intersecting in N , of which the coördinates are a_2 and b_2 . Compare the two emulsions at any value for the contrast, γ .

The curves under consideration will be, for example, those marked I and II, both at the same γ . For this particular value of γ the exposures required to give a standard density ($D_{\text{Std.}}$) are E_1 and E_2 , which will be in the same ratio as i_1 and i_2 . But if another value for the γ of the two emulsions is chosen, the ratio will change; and if the two plates are not at the same γ the relative speeds can not be determined at all except under the particular conditions chosen. In either case the value obtained is not constant and does not express any characteristic of the plates. This is precisely where the old method fails, and on such points much time and discussion have been wasted.

The constants a and b are fundamental characteristics of the two emulsions for the given developer, and the speed relations may be expressed in terms of them, as detailed below.

$$\frac{H_1}{H_2} = \frac{E_2}{E_1} = \frac{i_2}{i_1}. \quad (\text{from above})$$

$$\begin{aligned} \log \frac{H_1}{H_2} &= \log \frac{E_2}{E_1} = \log E_2 - \log E_1 = \log i_2 - \log i_1 = MN \\ &= BN - BM \qquad BN = a_2 \qquad BM = a_1 - MR. \end{aligned}$$

$$\text{But, } \frac{RQ}{MR} = \tan \alpha = \gamma. \text{ Hence, } MR = \frac{RQ}{\gamma} = \frac{b_1 - b_2}{\gamma}. \text{ (positive)}$$

$$\text{Hence, } \log \frac{H_1}{H_2} = \log \frac{E_2}{E_1} = a_2 - a_1 - \frac{b_1 - b_2}{\gamma}. \quad (13)$$

This expression holds for any value of γ . It shows that in such cases the relative speeds of the emulsion depend on γ , and the relations are such that when $b_2 > b_1$ (negatively) the speed of II compared with I increases with increase of γ ; when $b_2 < b_1$ the speed of II compared with I decreases with increase of γ . If either b_1 or b_2 equals zero, the expression simplifies. If both b_1 and b_2 equal zero, then the relative plate speeds are defined by a_2 and a_1 . That is,

$$\log \frac{H_1}{H_2} = \log \frac{E_2}{E_1} = \log \frac{i_2}{i_1} = \log i_2 - \log i_1 = a_2 - a_1,$$

a_2 being identical with $\log i_2$ and a_1 with $\log i_1$. Thus we have the original Hurter and Driffield relation. Therefore the latter holds only if the intersection points for the two families of curves lie on the $\log E$ axis, as Hurter and Driffield pointed out. In this case only is the emulsion speed independent of the contrast.

Now in the case of a single emulsion, say emulsion I in the figure, if b has any considerable value the absolute speed of the plate increases with γ . In the case of curves I and Ia, for example, the inertia decreases from i_1 to i_{1a} and the speed

increases from $H = \frac{k}{i_1}$ to $H = \frac{k}{i_{1a}}$. This is better shown by the following:

$$\log H = \log \frac{k}{i_1} = \log k - \log i_1.$$

From the figure $\frac{-b}{\log i_1 - a} = \gamma$, and $\log i_1 = a - \frac{b}{\gamma}$. (14)

Consequently $\log H = \log k - a + \frac{b}{\gamma}$. (15)

Hence, the lower the value of a , the greater the speed; the greater the absolute value of b , the less the speed; and the greater the value of γ , the greater the speed (for a given value of b). If $b = 0$, we have $\log H = \log k - a$, and the speed is independent of gamma.

We may define the absolute speed, in a purely arbitrary but general way, as inversely proportional to that exposure in visual meter-candle-seconds (of light from a definite source, such as screened acetylene) which is required to initiate the deposition of silver, assuming that the emulsion is developed to a gamma of unity and that the H. and D. curve consists entirely of a straight line. Practically, this is not so complex as it sounds. Referring to the figure, curve for emulsion I, for example, we simply state that $H = \frac{k}{i}$ where i is the value at $\gamma =$ unity and expressed preferably in terms of a and b , and in the proper units. From the figure it may be seen that at $\gamma = 1.0$, $\log i = a - b$. This is evident also from equation 14. Consequently, to fit the definition

$$\log H = \log k - a + b. \tag{16}$$

On this basis the relations for speeds between emulsions will be the same as if we chose densities actually on the straight line portions of the plate curves (so long as both the emulsions are at a gamma of unity). The arbitrary selection of the speed ratio at a particular value of γ is necessary if any definite speed number is to be assigned to an emulsion having a real value of b (and there are such emulsions). It should be clear from the above that for this case the speed value obtained varies with the contrast. To eliminate contrast, therefore, the constants a and b are determined and

the speed number expressed by the use of equation 16. When b is zero the method is as simple as the older one, and it may be made more precise.

Therefore, our conclusions are that a and b are the sensitometric constants desired, and that the use of i as a characteristic constant should be abandoned. Further, we find it possible to express the correct relations for the speed in terms of a and b , whether or not the speed is independent of the contrast.

For the experimental method of determining the constants a and b the reader is referred to Chapter I. In practice, for the purpose of speed measurements, it is sufficient to develop five pairs of plates for varying times and to plot the H. and D. and the D- γ curves for the standard exposure. a and b are computed from the latter.

DATA ON EMULSION SPEEDS AND THE VARIATION OF SPEED

1. VARIATION OF SPEED WITH EMULSION

The above conclusions were reached from examination of data from thousands of plates, about thirty different developing agents and fifteen different emulsions being used. The following typical cases are sufficient for illustration. Table 10 gives results for eight emulsions, each developed in three developers. Values of a , b , and H are given. H is found from equation 16 by assigning the value 100 to k and expressing a in units of the logarithms of relative exposures. Hence equation 16 becomes $\log H = 2 - a + b$. This expresses speed values (on an arbitrary scale) which are independent of γ when $b = 0$, and apply only for $\gamma = 1.0$ when b has a real value. Since in most cases $b = 0$, they may be considered to be parallel to the H. and D. speed numbers.

A great deal of data like those in Table 10 was obtained incidentally to other work. Owing to occasional difficulties in obtaining consistent and uniform results with certain developer and emulsion combinations no great precision could be obtained. However, it was demonstrated that, by the use of a suitable standard developer, a very satisfactory degree of precision and reproducibility in comparing emulsion speeds may be obtained by this method. The personal error is eliminated to a great extent, and the information obtained, especially if the emulsion under consideration does not behave in the normal way, is of more value than that obtained by the Hurter and Driffield method, where, as a rule, the inertia point is obtained from two plates.

TABLE 10
SPEED OF PLATES

Emulsion Used	M/20 Paramino-phenol hydrochloride (R 340.15)			M/20 Dimethylparaminophenol sulphate (R 354.1)			M/20 Pyrogallol (R 43.25)		
	<i>a</i>	<i>b</i>	<i>H</i>	<i>a</i>	<i>b</i>	<i>H</i>	<i>a</i>	<i>b</i>	<i>H</i>
Special Emulsion IX..	.14	-.17	49	.50	0	32	.14	.04	80
Special Emulsion VIII.	1.34	0	4.6	1.66	0	2.2	1.42	0	3.8
Special Emulsion XI..	1.18	0	6.6
Special Emulsion XII.	.58	-.22	16	0.73	-.14	13.5	.50	0	32
Pure Bromide III.....	1.99	0	1	2.00	0	1	1.72	0	1.9
Special Emulsion XIII.	1.74	-.21	1.1	1.68	-.25	1.2	1.65	-.24	1.3
Special Bromide XIV..	1.24	-.25	2.1	1.54	-.12	2.2
Film Special Emulsion XV.....	1.10	0	8	.88	0	13
Emulsion 3533.....	.12	0	76	-.32	0	210	-.88	0	760

Table 10 shows that there is an increase in speed when pyrogallol is used, and that paraminophenol increases the speed to a somewhat greater extent than dimethylparaminophenol. The effect of the developer is considered below. The Special Bromide Emulsion XIV, which contains some free bromide, persistently shows a real value for *b*. This may be interpreted in the light of what was said in the second chapter concerning the effect of bromide on the intersection point, —i. e., on the values of *a* and *b*. It was shown that normally, when no bromide is present, *b* = 0, but with increasing concentration of bromide *b* assumes a real value and increases, or the intersection point moves downward. *a* is not affected. Consequently we may infer that if an emulsion shows a real value of *b*, it contains some free bromide, as we do not know of any other explanation of this result. The bromide may be held by adsorption or inclusion but must be present when development takes place. Further, according to earlier theories, the depression of the intersection point (the value of *b*), for a given concentration of bromide in the emulsion is less the greater the reduction potential of the developer. Pyrogallol has the highest reduction potential of the three developers, and in three out of four cases showing a real value of *b*, the latter is smallest with pyrogallol; that is, in these three experiments the free bromide in the emulsion has the least effect when pyrogallol is used. The presence of free bromide in the emulsion can not be considered detrimental, provided the depression produced is not too large.

The above explanation may account for various effects observed with certain developers and emulsions. Hydroquinone without bromide, for example, often shows a shift or "regression" of the inertia point. Hydroquinone, having a low reduction potential, and being therefore very sensitive to bromide, may be affected by an amount of free bromide in the emulsion so small that it has no effect on other developers. The foregoing facts may also account for the successful use of pyrogallol in speed determinations. This does not imply that other developing agents will not do as well, but it is true that many developers whose reduction potential is as great or greater than that of pyrogallol give much more fog, thereby vitiating the results.

That some slow emulsions show a considerable value for b also partially accounts for the fact that these emulsions are relatively faster when developed to high gammas. However, this phenomenon may be explained partly by other sensitometric considerations.

2. EFFECT OF BROMIDE ON SPEED

If certain developers (of low reduction potential) containing an appreciable amount of bromide are used, the actual effective speed of the plate is reduced because of the depression in density produced by the free bromide in the developer. The extent of this effect is, of course, measured by the effect on b , as shown by equation 16—

$$\log H = \log k - a + b.$$

Although the question of the advantages and disadvantages of the use of bromide has been debated again and again, we may now state with a reasonable degree of certainty that there is a real advantage in the intelligent use of bromide in the developer. To present this point properly would require a separate paper and the use of results not yet explained. However, the following facts may be presented:

As a rule, the fogging propensity of a developer is not connected with its reduction potential, many developers of exceptionally low potential giving much fog;

With most developers the growth of fog is affected to a very much greater extent by bromide than is the growth of image density;

For a developer of relatively high reduction potential (monomethylparaminophenol, pyrogallol, etc.), an amount of bromide sufficient practically to inhibit fog even with

relatively prolonged development does not greatly affect the density (i. e., the depression is small) provided the concentration of the developing agent is great enough.

In other words, for the preceding conditions, bromide cuts down the fog but does not lower the effective speed of the plate.

As a general rule, therefore (other conditions being equal), there is an advantage in the use of a high reduction potential developer of suitable character with enough bromide to minimize chemical fog.

In speed determinations on ordinary emulsions, especially if developers or emulsions apt to fog are used, it is a distinct advantage to use bromide. If no bromide is used, b is assumed 0, which is true for nearly all ordinary plates. a is not affected by bromide. The speed may therefore be determined with sufficient bromide to eliminate the fog error. (See Chapter VIII on distribution of fog over the image.)

3. EFFECT OF THE DEVELOPING AGENT

This is another question which has been the subject of much discussion. While the determination of emulsion speeds for different ordinary emulsions may be made easily, the same measurements with many different developing agents on a plate of sufficient latitude (usually a moderately fast plate), will be attended by many difficulties. This is especially true for developers such as those employed in the present work, where the concentrations are always the same, and no attempt is made to obtain good practicable formulae. This series of developers represents similar conditions chemically, and we believe that on the whole the results are of value from the theoretical point of view. It is emphasized here and later that little practical importance is attached to the data (given below), on the effect of the developing agent, as they would not be duplicated by the use of commercial developers. A similar application of the method with the latter, however, could not fail to be of value.

The greatest error in the present problem is that due to fog. It has been quite conclusively demonstrated that fog does not lie uniformly distributed over the image, but is greatest over the low densities. Hence it is seen that as fog increases it can change the character of the plate curve, giving a false result. This leads to false values of $\log i$, of a , and of b , or in some cases renders their determination impossible except over the narrow range where no fog is produced. In such cases there is great advantage in the use of bromide.

In Table 11 are given results, obtained with seven developers used on a Seed 23 emulsion. These were obtained from bromide depression data, so that the value of a is the average from determinations at several concentrations of bromide, and may therefore be considered quite reliable. b was zero. The speed numbers (H) are found, as above, from $\log H = \log k - a + b$, where k is 100 and a is expressed in units of $\log E_{\text{Relative}}$. The reduction potentials of the developers are recorded also.

TABLE 11
INFLUENCE OF THE DEVELOPING AGENT ON PLATE SPEED

Developer	π_{Br}	a	H
M/20 Hydroquinone.....	1.0	.07	85
Paraphenyglycine.....	1.6	.12	76
Toluhydroquinone.....	2.2	-.24	174
Paraminophenol hydrochloride.....	6	.49	32
Chlorhydroquinone.....	7	.10	80
Bromhydroquinone.....	21	.49	32
Monomethylparaminophenol sulphate.....	23	.63	23

($b = 0$)

There is no regularity in these results. On another and faster emulsion the following were obtained:

TABLE 12

Developer	π_{Br}	a	H
Paraphenyglycine.....	1.6	-.17	148
Paraminophenol hydrochloride.....	6	+.12	76
Dimethylparaminophenol sulphate.....	10	+.28	53
Pyrogallol.....	16	-.05	112

Again no connection between reduction potential and plate speed is apparent. However, pyrogallol, paraminophenol, and dimethylparaminophenol stand in the same order as to speed as in Table 10.

Table 13 gives results less reliable than those above, as the data were obtained incidentally to other work for which no bromide was used. The range of developing agents is much greater and the same general trend is indicated as in Tables 11 and 12, though the results are somewhat erratic and some of them no doubt are erroneous. Each value of a is the result of but one determination, and that without bromide. The D - γ curve for each case is based on from ten to twenty pairs of plates, plates showing bad fog being included. The determinations marked with an X are from the most consistent data. A Seed 30 emulsion was used throughout and all the conditions were as previously described.

TABLE 13

INFLUENCE OF THE DEVELOPING AGENT ON PLATE SPEED

Experiment Number			π_{Br}	a	b	H
131	M/10	Ferrous oxalate.....	0.3	0	0	$\times 100$
132	M/20	Paraphenylenediamine hydrochloride, no alkali.....	0.3	-.52	0	330
126	M/20	Hydroquinone.....	1.0	-.66	0	$\times 460$
136	M/20	Toluhydroquinone.....	2.2	-.24	0	$\times 175$
123-140	M/20	Paraminophenol hydrochloride...	6	.12	0	$\times 76$
165-167	M/20	Chlorhydroquinone.....	7	.20	0	$\times 63$
127	M/20	Paramino-orthocresol sulphate...	7	-.54	0	$\times 350$
125	M/20	Dimethylparaminophenol sulphate	10	-.32	0	$\times 210$
124	M/20	Pyrogallol.....	16	-.88	0	$\times 760$
135	M/20	Monomethylparaminophenol sulphate.....	20	0	0	$\times 100$
144	M/25	Bromhydroquinone.....	21	.20	0	$\times 63$
130	M/20	Methylparamino-orthocresol...	23	-.78	0	600
145	M/20	Diamidophenol hydrochloride, no alkali.....	30-40	.20	0	63
129	M/20	Dichlorhydroquinone.....		-.48	0	$\times 300$
133	M/20	Dibromhydroquinone.....		-.60	0	$\times 400$
137	M/20	Paraminomethylcresol hydrochloride.....		-1.00	0	$\times 1000$
146	M/20	Diamidophenol, + alkali.....		-.60	0	$\times 400$
154	M/20	Pyrocatechin.....		+.26	0	$\times 55$
172	M/20	Phenylparaminophenol.....		-.06	0	$\times 115$
184	M/20	Edinol.....		+.46	0	35
195	M/20	Eikonogen.....		-.26	0	180
193	M/20	Hydroxylamine hydrochloride + 0.25M, NaOH.....		+.12	0	76
194		Commercial Pyro Developer (containing bromide).....		+.20	0	.63

Log $E = 2.4$ (relative scale)
Seed 30 Emulsion

We doubt that such wide deviations occur. Indeed, this conclusion is upheld by the fact that if a certain fixed exposure which gives densities lying well up on the plate curves, out of the region of fog, is selected, the densities (on prolonged development, at least), vary with the developer, showing a general tendency to increase with reduction potential. But the variation is not so great as these speed values would indicate. Consequently we must attribute some of this deviation to fog, which, as indicated, can change the contrast and inertia values.

It is clear from the above and from many other experiments that variations of emulsion speed with developing agents are far from orderly, and that the speed obtained in a given case

depends on several factors, among which are, undoubtedly, the reduction potential of the developer, the general balance of the ingredients of the solution (which conditions hydrolysis and the character of secondary reactions), the physical action of the developer on the gelatine and on the silver halide, and the fogging propensity of the developer. From data on velocity and maximum density, to be presented later, it is concluded that, other conditions being equal, the speed increases somewhat with increasing reduction potential. At any rate, it should not be concluded that the deviations found (especially those in Table 13) necessarily obtain for any conditions other than those described. It will be found that the results with commercial developing formulae are much more nearly balanced.

4. INFLUENCE OF THE CONCENTRATIONS OF THE OTHER INGREDIENTS OF THE DEVELOPER

These complex effects are not capable of ready interpretation. As the state of balance among the various ingredients of the developers is changed the degree of hydrolysis and dissociation of the developing substance varies. The physical action of the developing solution probably changes to some extent also. To these and to the other factors mentioned above we may attribute the results, but without definite knowledge that it is correct to do so.

The changes in the constant a for the hydroquinone developer are shown in Fig. 26. The concentrations of sulphite,

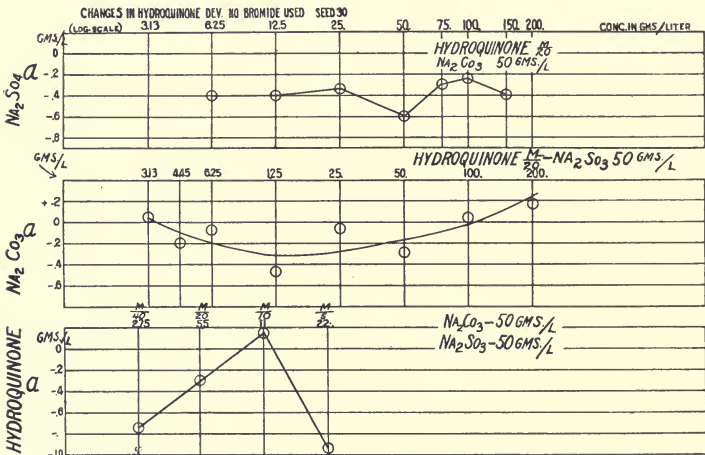

Figs. 26-A, B and C

carbonate, and hydroquinone were varied as indicated. Variation in bromide concentration produces no change in a , as previously shown.

The lower the value of a here, the higher the speed. In all cases $b = 0$.

There is practically no change in speed with changing sulphite concentration over a wide range (Fig. 26A).

There is, however, a marked increase of speed as the alkali concentration is increased until a maximum is reached, after which the speed decreases (a increases). (Fig. 26B). This may be accounted for by the hydrolysis relations and also by the physical effect of the alkali on the gelatine, excess of alkali causing a hardening of the gelatine, while over the lower range a gradual softening takes place.

Insufficient data were obtained on variations of hydroquinone concentration, but such results as are available are shown in Fig. 26C.

It is to be understood that these relations may be quite different with other developing agents.

5. PRECISION OF THE METHOD. RESULTS WITH COMMERCIAL EMULSION AND DEVELOPER

The data in Table 14 illustrate the precision which can be attained by the use of the method described above. Under favorable conditions the original Hurter and Driffeld method was found to give slightly greater deviations from a mean. Under less favorable conditions the Hurter and Driffeld method would require modification to approach the reproducibility and consistency of the method described here.

A panchromatic plate was used with a commercial pyrogallol developer. Exposures were made under varying conditions which need not be described at present. Five pairs of plates were used for each determination of a . Three separate determinations were made, numbered 1, 2, and 3. ΔS is the deviation from average speed.

TABLE 14

	I		II		III		IV	
	Speed	ΔS	Speed	ΔS	Speed	ΔS	Speed	ΔS
1	85.0	+4.8	66.0	+1.5	54.0	-0.9	33.9	-0.9
2	77.5	-2.7	59.2	-5.2	52.8	-2.1	31.7	-3.1
3	79.3	-1.9	68.2	+3.7	57.9	+3.0	38.9	+4.1
Mean	80.2		64.5		54.9		34.8	
Average deviation		2.8%		5.4%		3.6%		7.8%

The deviations for sixteen such cases averaged 2.3 per cent. The old (H. and D.) method carried out in exactly the same way for sixteen cases gave 3.3 per cent deviation. For the latter the inertia points of five pairs of plates were averaged. In the usual routine application of this method but two pairs are used.

CONCLUSIONS

The inertia point is not a fixed characteristic of an emulsion, and it is better to avoid the use of i or $\log i$ as constants wherever possible.

More fundamental sensitometric constants for given conditions are a and b , the coördinates of the point of intersection of the H. and D. straight lines obtained by varying the times of development.

a and b are determined from the relations

$$\begin{aligned} a &= \log E - \theta \\ b &= -A \theta \end{aligned}$$

by the use of the D - γ function, for which θ is the slope and A the intercept on the γ axis. $\log E$ is the standard exposure for which the D - γ curve is plotted.

When $b = 0$ the H. and D. straight lines intersect on the $\log E$ axis. This is true for nearly all ordinary emulsions and for developers containing no bromide.

If sufficient bromide is present b differs from zero and increases (negatively) with increasing bromide concentration. In such cases the new method is of advantage in interpreting the results.

A few of the slower emulsions contain free bromide, so that they exhibit a regression of inertia with increasing development—i. e., have a non-vanishing b . This effect is less for an emulsion of this kind when a developer of high reduction potential is used than with one of low reduction potential.

If bromide is present in the developer, the relations are the same as in the preceding. A developer of high reduction potential may be used with more bromide without lowering the effective speed.

There is considerable advantage in the use of a suitable developer of high reduction potential with enough bromide to cut down fog.

In many cases, speed determinations are made more easily if bromide is used judiciously.

The emulsion speed does not vary consistently with any known characteristic of a developer, but is probably affected by the factors noted above. Others of these factors being the same, it is believed that the speed increases with increasing reduction potential.

The method of speed determination described can be made sufficiently accurate for all ordinary emulsions and developers.

The conclusions reached apply only to the conditions stated—i. e., for the region of correct exposure (the straight line portion of the plate curve)—just as in the original speed determinations by Hurter and Driffield. A separate investigation will be required to measure relative speeds for the region of under-exposure. However, so far as the effect of the developer is concerned (as studied here), the relations would not be different.

CHAPTER V

Velocity of Development, the Velocity Equation, and Methods of Evaluating the Velocity and Equilibrium Constants

In preceding chapters an attempt has been made to study the affinities of certain organic reducing agents, and to correlate their photographic properties on this basis. However careful such work may be it cannot be entirely successful because the reduction potential of a developer is not always the chief property in conditioning the nature of its photographic action. Moreover, other properties important in this respect are relatively unknown, which makes a fair quantitative comparison of developing agents extremely difficult. Among factors influencing the results of such comparisons we may mention those contributing to differences in reaction resistance, in physical action (adsorption, penetration, effect of tanning, etc.), and in the chemical system affecting the entire reaction. The reaction resistance is influenced by factors of which we know little. The solvent action of the developer on silver bromide, the nature of the chemical reactions among the ingredients of the solution (developing agent, alkali, and sulphite), the degrees of dissociation and hydrolysis of the resultant compounds, and the effects of relatively high concentrations of other ions—all these influence reaction resistance and determine the chemical state of the system.

It was felt that a study of reaction velocities might lead to a better understanding of these questions, and the work about to be described was undertaken.

In working out methods for the study of the velocity of development, it was decided not to make use of the relation between the contrast (γ) of the plate and the time of development, as has been done to some extent by other investigators, but to use the chemically more logical quantity density (D), which has been defined as being proportional to the mass of silver. The problem thus becomes a physico-chemical one, dealing with familiar relations and quantities. It is evident that here we are dealing with a heterogeneous reaction very probably susceptible to disturbing influences, as such reactions often are. A rough preliminary analysis of one case will show the method of examining the velocity and

acceleration curves. The data were obtained by developing a pure silver bromide emulsion in M/20 paraphenyglycine (with 50 grams of sulphite and 50 grams of carbonate per liter) which contained M/100 potassium bromide. In Fig. 27A density (D) is plotted against the time of development for a fixed exposure, as will be explained directly. The slope of the curve at any time (t) is the velocity of development at that instant. By plotting the velocity against the time the so-called acceleration curve, Fig. 27B, is obtained. The velocity is expressed in terms of density developed per minute.

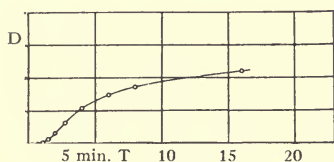

Fig. 27-A

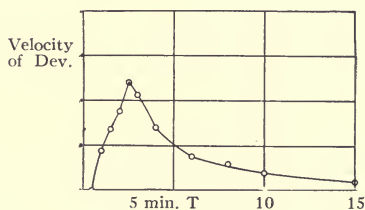

Fig. 27-B

The example chosen shows a well defined period of induction, or period of increasing velocity—a characteristic of photographic development, but not always so well shown. In fact, in many cases it is practically absent, and unless the experimental work is exceptionally accurate it is best ignored. However, the existence of this period of induction has been generally recognized as a feature of the kind of reaction we are investigating here. It is evident from the figures that more or less time elapses before there is measurable development, and that the velocity then rapidly rises to a maximum, after which it decreases in the usual way as the amount of material remaining to be acted upon decreases.

A period of acceleration or induction is usually accounted for by inherent reaction resistance or by the reaction taking place in a series of intermediate steps, or by both. The factors generally considered important in producing a period of induction in photographic development are (1) the time required for the invasion of the developer, and (2) the time required to saturate the solution in the emulsion with silver after reduction begins. Neither seems to the writer to account sufficiently well for the long periods of delay observed with some developers.¹

¹ See Sheppard, S. E. and Meyer G., Chemical induction in photographic development. *J. Amer. Chem. Soc.* **42** : 689. 1920.

It should be understood that the period of acceleration, or what is termed the period of induction, is ignored in the present discussion, as it is generally of short duration. The term refers to the delay before the reaction begins.

It may be seen from a first analysis that velocity curves of the usual kind are obtained, and that these should be capable of interpretation by ordinary methods. The immediate problem, therefore, is to investigate the possibility of fitting a mathematical expression to the experimental data on velocity of development—that is, an equation which properly describes the course of reaction with time. Having found methods for doing this, it becomes possible to compare developers and to discover what effect various conditions have on both the velocity and the end-point.

PREVIOUS WORK ON VELOCITY EQUATIONS

Hurter and Driffield first formulated the relation between the density produced for a given exposure and the time for which the plate had been developed, using the expression

$$D = D_{\infty} (1 - a^t), \quad (17)$$

where D is the density at time t , D_{∞} the ultimate density, and a a constant. This equation was based on certain assumptions as to the arrangement of the silver bromide particles affected by light and as to the mechanism of penetration and reduction by the developer. These assumptions were later questioned and are now practically discredited.

However, Sheppard developed in a different way an equation resembling that of Hurter and Driffield. He found that the velocity of development was obtainable by the expression

$$\frac{dD}{dt} = K (D_{\infty} - D), \quad (18)$$

where as usual D signifies the density at time t , D_{∞} the ultimate density, a quantity proportional to the mass of latent image, and K a constant. Sheppard deduces that K is equal to

$\frac{\Delta a}{S}$, Δ being the diffusion constant for the developer, a the concentration of the developer, and S the "diffusion path." This simple expression (equation 18) for a heterogeneous reaction is obtained by assuming that the velocity of development depends chiefly on diffusion processes. There is much experimental evidence to support this view. Nernst developed a theory for reaction velocities in heterogeneous systems,

assuming that diffusion is predominant. But this theory evidently does not take into account all the phenomena encountered.

Basing his reasoning on Wilderman's theory, Sheppard formulates for the case of ferrous oxalate a more complete expression for the velocity, which includes the view that development is a reversible reaction. Omitting the intermediate steps we may write this equation

$$\frac{dD}{dt} = K (D_{\infty} - D) \frac{b - aD}{h (D_{\infty} - D) + d} \quad (19)$$

Here, a , b , h , and d are constants which include such factors as equilibrium constants for the various reactions considered, equilibrium concentrations, and surfaces of the developable halide and of silver.

By replacing b and a in such a way that $b/a = p\xi$, where ξ represents the equilibrium constant of development, the above equation becomes, on integration (as suggested by Colby),

$$Kt = \log \frac{p\xi}{p\xi - D} - \frac{d}{(d + h) (D_{\infty} - p\xi)} \log \frac{D_{\infty}}{D_{\infty} - D} \quad (20)$$

Upon closer examination, this relation is seen to resemble the integrated form of equation 18, which is

$$Kt = \log \frac{D_{\infty}}{D_{\infty} - D}. \quad (21)$$

In equation 20, $p\xi$ represents the equilibrium value of the density developed, or the maximum density corresponding to D_{∞} in (21). D_{∞} as used in (20) indicates the density or mass of latent image which can be developed in the given case on infinite development. $p\xi$ therefore tends to approach D_{∞} , depending on a number of conditions which will be enumerated elsewhere. Equation 20 differs from (21) in that there is a correction term in the former which, as Sheppard states, expresses the effect of reversibility, but is of importance only when there is a high concentration of bromide or of the oxidized developer.

In ordinary alkaline development there are disturbing factors which are not included in equation 20, so that this is probably only an approximation. In fact, it has been obtained by a rather free use of assumptions as to the state of balance among the various reactions. Other reactions which disturb this balance may occur. Even if we could determine

these disturbing influences and their effect the velocity function would probably be so complicated that it could not be integrated to any useful form. Because of the very great difficulties of enumerating the constants p , ξ , d , and h , especially in alkaline development, and because of our present lack of knowledge of the mass of the latent image, it is impossible to test this equation. This matter will be discussed more fully after more experimental evidence has been presented.

EXPERIMENTAL METHODS

The general methods used by Hurter and Driffeld and by Sheppard and Mees were followed in the present work, with such modifications as seemed necessary. Although in general the entire procedure resembles very closely that used in other chemical kinetic investigations, the reader who has but little occasion to interpret sensitometric data may find it somewhat confusing. For this reason the methods will be described in some detail.

It is our purpose, first, to construct for a given constant exposure a curve showing the growth of density with time of development. Since (under usual conditions), density is proportional to mass of silver, there results a velocity curve of the usual type, showing the amount of silver produced at any time of development t . To obtain this it is sufficient to illuminate a plate uniformly, cut it up into strips, and develop the strips under constant conditions for different lengths of time. After fixing, washing, and drying, the densities of the various strips may be determined and plotted against the time of development corresponding to each density. But lack of sufficient uniformity in exposure and in sensitiveness of large plates, as well as a rather high percentage of accidental errors, make this procedure less reliable than is required in the present investigation.

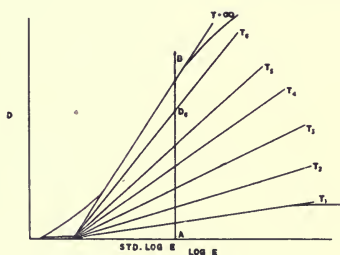

Fig 28

Better results are obtained from the type of data mentioned in previous chapters, and much of the same material can be used here. It has been shown that a series of plates, exposed in the sensitometer in a definite way, and developed for varying times, gives a series of H. and D. curves the straight line portions of

which meet in a point (for practically all cases where emulsion or developer do not contain soluble bromides). Fig. 28 shows this for the normal unbromided developer.

The toe and shoulder of the H. and D. curve are drawn for the upper and lower curves only. The lines represent the straight line portions of the H. and D. curves for plates developed for the times t_1 , etc., up to t_∞ . Similar data were obtained in the study of reduction potential by exposing plates in a sensitometer and developing them in pairs for varying times at a constant temperature in a thermostat, as previously described.

If, now, we take a cross section of this series of curves at AB —i. e., use a standard value of $\log E$, we have the information desired—the growth of density with time of development, the exposure being fixed. This method is somewhat more accurate than that of using a single flashed plate, as first described, because if we use the value D_6 , for example, as the intersection of the H. and D. smoothed curve, and AB , its value is influenced by the values obtained for the other densities on the plate. That is, D_6 represents an average of several values. Any one attempting sensitometric work on a large scale will appreciate some of the difficulties encountered as well as the desirability of these methods.

As stated above, it has been found that with many of the developers used commercially and with good plates and care, uniform and consistent results may be obtained. But when a large number of different developers in which the equivalent concentrations of all the ingredients are always the same are used on a large number of different emulsions, many and wide variations are likely to occur, probably because some of the developers so made are not practically useful. But for purposes of comparison it is important to use developing agents at the same equivalent concentration, and this almost no previous workers (except Sheppard and Mees) have done.

Returning to the discussion of the curves, the value for the density coordinates of the intersections of AB with the straight lines plotted against the corresponding times of development give a curve similar to that shown in Fig. 29, in which the period of induction is disregarded, as explained above. The curve, which is

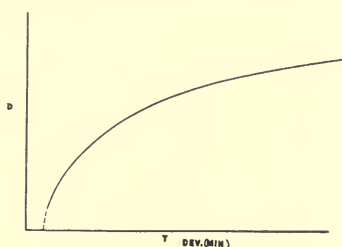

Fig. 29

at least roughly exponential, has coordinates in terms of mass of silver and time of development.

Experimental evidence of this kind has made it possible to study the properties of the curves, thereby explaining some of the relations between the photographic and the chemical properties of the developing agents used. In studying the velocity curves about 15,000 plates, exposed to acetylene screened to daylight quality in a sliding-plate (non-intermittent) electrically operated sensitometer, and developed in various water-jacketed tubes and tanks supplied by water at 20° C. from a thermostat, were examined. A constant value of the exposure was used in plotting the data. This exposure ($\log \bar{E} = 2.4$) represented 1.4 candle meter-seconds of screened acetylene.

As stated in a previous chapter, all developers were made up to standard concentration and, unless otherwise specified, every developer contains in one liter 1/20 of the gram-molecular weight of the developing agent with 50 grams per liter each of sodium sulphite and sodium carbonate. No bromide or other substances are present unless so stated.

A number of different emulsions and developing agents were examined, of which a few will be described. It is obviously impossible to record the results of many of the experiments.

INTERPRETATION OF RESULTS

Taking up first an analysis of the curves, the experimental results of previous workers as well as theoretical deduction have indicated that the relation between density and time of development at constant exposure may be expressed by an equation of the general type

$$Kt = \log \frac{D_{\infty}}{D_{\infty} - D} \text{ or } D = D_{\infty} (1 - e^{-Kt}). \quad (22)$$

This form would indicate that photographic development proceeds approximately in accordance with the law for a unimolecular homogeneous reaction, and that the concentration of only one substance, the silver halide forming the latent image, is changing. Hurter and Driffield gave very meager data in support of their equation. The results obtained by Sheppard and by Sheppard and Mees, who investigated the relation much more thoroughly, especially for ferrous salts, indicate that the ferrous salts as developers (acid developers) follow this law rather closely. The results obtained with alkaline developers did not fit the equation so well, though the range of times used was too small for conclusive evidence.

The writer, working over a much greater territory, finds many cases where the expression under consideration does not fit the results at all. The general conclusions reached, however, are capable of interpretation in harmony with Sheppard and Mees' results.

It is hardly to be expected that the course of so complicated a process as photographic development in the presence of alkali could be described by so simple a law, since we know of changes which take place at various stages. Even if the law formulated in equation 22 held approximately over a considerable range, there are possibilities of several complications which might increase in importance as time went on, or be of more importance in the early stages of the process, thereby giving rise to departures from this law. For example, it is unlikely that diffusion of the developer into the gelatine emulsion and of the reaction products out of it is the simple process assumed. Through absorption and various other physical phenomena, relatively large local changes in the concentration of the developer may occur. In such a case, development might approximate a second order reaction, the velocity being proportional both to the mass of latent image remaining to be reduced and to the concentration of the developer. That is, the quasi-bimolecular form,

$$\frac{dD}{dt} = K(D_{\infty} - D)(A - D), \quad (23)$$

may be a more nearly correct expression. A is the concentration of the developer at the beginning and D equivalents have been used at the time t . The integrated form of (23) is

$$K = \frac{1}{t} \log \frac{D_{\infty}(A - D)}{(D_{\infty} - D)A}. \quad (24)$$

If over a range of times D is small compared with A (and this is often the case, a very small amount of silver being formed compared with the amount of developing agent present), then $\frac{A - D}{A}$ is nearly equal to unity, and equation 24 becomes practically the first order form. But if because of the tanning of gelatine, or by other mechanical means, inclusion of the developer occurs, so that its local concentration changes as time goes on, then a gradual departure from the first order law takes place. Something like this does occur, but the phenomena are undoubtedly more complex than the above explanation suggests.

It is not impossible that two successive reactions of the first order take place, giving rise to disturbing influences at the beginning. As Mellor points out, if k_1 and k_2 for two such reactions are widely different, the general trend of the reaction is a close approximation to a single first order reaction after "initial disturbances," and the sooner they take place the greater the ratio k_1/k_2 .

It is not intended to advocate the view that photographic development proceeds through a well defined intermediate stage, but it has become evident that many complex phenomena are involved in the failure of the reaction to follow any definite law throughout its course, and so little is known of the mechanism of the oxidation of the reducing agents themselves that an intermediate reaction is a possibility.

Whatever views may be held on the matter, the best previous work indicates that as a first approximation the velocity of development is expressed by the ordinary law of mass action for a first order reaction as given above—

$$\frac{dD}{dt} = K(D_\infty - D) \text{ or, integrated, } Kt = \log \frac{D_\infty}{D_\infty - D}. \quad (21)$$

Equation 21 may be applied to the density-time data as a beginning. From it or its exponential form $D = D_\infty(1 - e^{-Kt})$, it is evident that when $t = 0$, $D = 0$; and thus this equation represents a family of exponential curves through the origin. The density-time curve shown in Fig. 29 is certainly not well fitted by this form if the curve intersects the horizontal axis very far from the origin—that is, if the time of appearance is long. The method of applying equation 21 to the data is as follows: If the correct value of D_∞ is inserted and $\log \frac{D_\infty}{D_\infty - D}$ plotted against the times corresponding to the observed values of D used in $\log \frac{D_\infty}{D_\infty - D}$, a straight line of slope K is obtained. Since it is necessary, as shown above, that $D = 0$ when $t = 0$, it is also a condition for this graphical solution that the origin be used as a point on the line—i. e., that the straight line pass through the origin. When $t = 0$ and $D = 0$, $\log \frac{D_\infty}{D_\infty - D}$ also = 0. The equation $D = D_\infty(1 - e^{-Kt})$ will fit the observed data over the range of times where $\log \frac{D_\infty}{D_\infty - D}$ plotted against t gives a straight line. Bloch used this method incidentally to other work, but not enough data are given in

his account to throw light on the velocity equation. In the present application D_∞ is enumerated by trial and error, that value being taken which gives a straight line over the maximum range. However, in instances where equation 21 fits at all over any range, the value of D_∞ can be approximated from the experimental results, or may even be obtained by long development. The method of choosing the value of D_∞ to be used and its experimental verification will be given in greater detail later.

It should be noted that logarithms to the base e are used unless otherwise indicated.

It was found that equation 21 fitted the data for only those cases where the time of appearance was exceedingly short, and then only for the early stages, usually for not more than three or at the most five minutes' development. Many cases could be presented but space does not permit. All the experiments show that the development reaction follows the usual first order law for a time but that, on the whole, the latter law does not completely describe the process. This fact, observed repeatedly, makes it appear probable that new phenomena predominate as development proceeds.

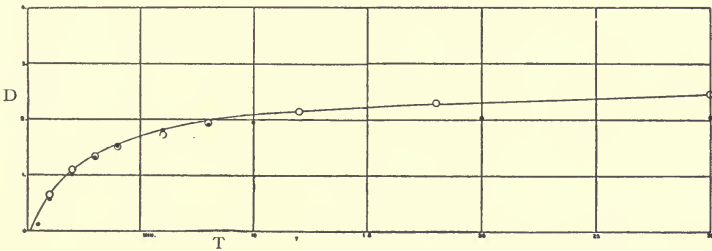

Fig. 30-A

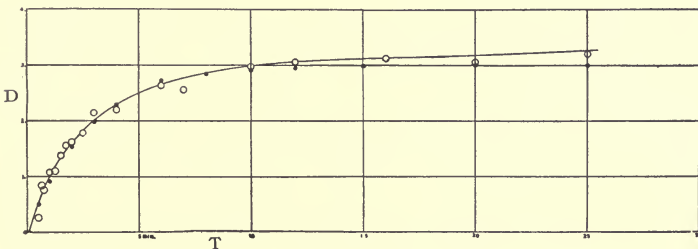

Fig. 30-B

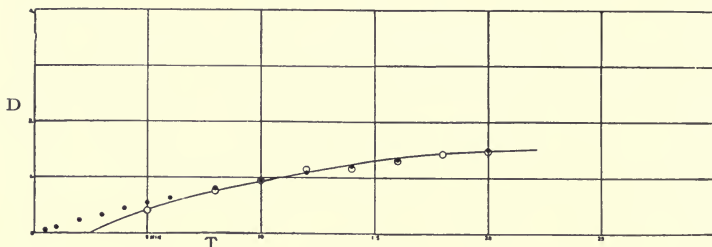

Fig. 30-C

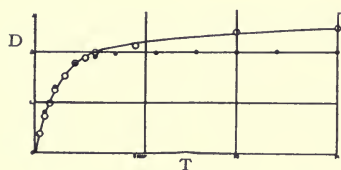

Fig. 30-D

In Fig. 30 A, B, C, and D the experimental results and the densities computed from the equation $D = D_{\infty} (1 - e^{-kt})$ are given. For experiments A, B, and C an ordinary fast emulsion was used. The developers used were:

- A. M/20 Paraminophenol hydrochloride (pure);
- B. M/20 Pyrogallol (pure);
- C. Same as A + 0.16 M potassium bromide;
- D. M/20 Monomethylparaminophenol sulphate of high purity.

Experiment D was carried out on a slow emulsion.

The constants to be used in computing the densities were determined by the method described. The attempt was made in each case to fit the data over the maximum range from the beginning. A, B, and D are cases where the time of appearance is very short and the equation might be expected to apply. With each a value of D_{∞} is necessary (in order to give

$\log \frac{D_{\infty}}{D_{\infty} - D}$ against t as a straight line through the origin)

which is exceeded on longer development, as may be clearly seen from the figures. Fig. 30C is a case in which we could not expect the equation to apply. The time of appearance is very long. Therefore, the computed and experimental curves do not agree at the beginning, since the equation necessitates a curve through the origin, although no density is obtained for three or four minutes' development. For longer times insufficient data were secured, so that the usual departure in the later stages of development is not evident.

Fig. 30D shows more markedly what was often found to be the case—that the equation under discussion fits the data at the beginning and usually can not be applied at any other

stage of the reaction. The method of evaluating the constants for this experiment will be given later, and then the limited application of the simple first order equation will be evident. In this case neither a higher nor a lower value of D_{∞} gives better agreement.

In case the time of appearance is long—i. e., there is a considerable delay—the velocity equation can be corrected to a certain extent by allowing for the initial period of apparent inactivity. In equation 21 the correction is:

$$K (t - t_0) = \log \frac{D_{\infty}}{D_{\infty} - D}, \quad (25)$$

where t_0 is the induction period. In its exponential form

$$(25) \text{ becomes } D = D_{\infty} (1 - e^{-K(t-t_0)}). \quad (26)$$

The velocity of the reaction is the same as before, i. e.,

$$\frac{dD}{dt} = K (D_{\infty} - D).$$

Equation 25 is the basis for applying the data. $\text{Log} \frac{D_{\infty}}{D_{\infty} - D}$ is plotted against the time as before, such a value of D_{∞} being chosen as will give a straight line when observed values of density are inserted, and the function is plotted against the corresponding times. The slope of the straight line is K and the intercept on the time axis gives t_0 , or the induction period. K is defined here in the usual sense, as the velocity when unit density remains to be developed.

This equation is quite applicable, however great the period of induction, but very often the curves are fitted for the beginning of the reaction only.

The curve in Fig. 31 illustrates the use of equation 26 on the data used with equation 21 in Fig. 30, curve C. The densities indicated by the circles are computed from equation 26, and agree well with results obtained.

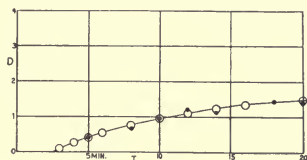

Fig. 31

Many results were computed for this equation. The general results tend to show that the corrected equation represents the facts over a considerable range from the beginning of the reaction. The time range for which it fits varies widely, in some cases being for only a minute, while for others an observed range of fifteen minutes is satisfactorily fitted. From

results which will be discussed later it is concluded that photographic development represents a series of phenomena which change with time; that because of this fact it is impossible or at best very difficult to describe the entire process by one mathematical expression; and that, since the principal information desired is the value of D_{∞} (the equilibrium point for given conditions), it is justifiable and of more value to turn our attention to better means of determining this important constant, and accordingly to neglect the early stages of the reaction.

The use of equation 25 often necessitates values of D_{∞} which are obtained in a short time and which are greatly exceeded on longer development. Experiments show that in the average case the density continues to increase for a long time, and that the ultimate density is very likely to have a higher value than any reached within the usual limits.

It was found in the great majority of cases that with a fairly reasonable estimate of D_{∞} in the function $\log \frac{D_{\infty}}{D_{\infty} - D}$ the latter would give a straight line over a considerable range when plotted against the logarithm of the time instead of against the time itself. It was evident that this method would be quite satisfactory as giving an empirical expression describing the reaction beyond the initial period, as the data were usually well fitted beyond two or three minutes' development. In other words, here the discrepancies between observation and theory were at the beginning. This fact was very carefully examined in many cases, but in none of them could the early stage be represented by the expression used for the curve as a whole.

When $\log \frac{D_{\infty}}{D_{\infty} - D}$ is plotted against $\log t$ as just described, the equation for the straight line is

$$K (\log t - \log t_0) = \log \frac{D_{\infty}}{D_{\infty} - D}, \quad (27)$$

the slope being K as before, and the intercept on the $\log t$ axis $\log t_0$. In the exponential form this is

$$D = D_{\infty} (1 - e^{-K \log t/t_0}), \quad (28)$$

which, differentiated for the velocity, becomes

$$\frac{dD}{dt} = \frac{K}{t} (D_{\infty} - D). \quad (29)$$

So far as the writer is aware this is different from other "corrected" forms for the velocity equation, many of which have been published. Equation 29 indicates that the velocity is inversely proportional to the time, a fact for which there is no satisfactory explanation at present. There may be some poisoning influence from oxidation products or the like, but experimental evidence for this is lacking. It seems possible that the velocity equation describes a complex effect from stored up oxidation products, tanning, and, in general, defective diffusion. Quantitatively, this effect is probably not the simple function of time required by the above relation, but the various factors are taken up in such a way that K/t gives a close approximation over a considerable range. Here K is a constant, as before, but its significance must be different since it undoubtedly contains new factors. From equation 29, K may be defined as the product of the velocity and the time of development when unit density remains to be developed.

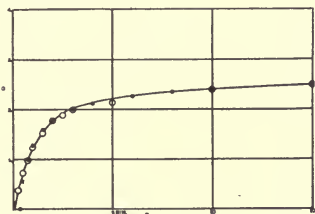

Fig. 32-A

Fig. 32 illustrates quite completely the entire process of fitting an equation to the data. The experiment was carried out with M/20 monomethylparaminophenol sulphate on a Seed 23 emulsion. This developer (among others) invariably showed wide departure from the first order relation

$\frac{dD}{dt} = K (D_{\infty} - D)$. The open circles in Fig. 32A show the observed densities. Using data from the smoothed curve

through these points, values of $\log \frac{D_{\infty}}{D_{\infty} - D}$ were computed

for several estimates of D_{∞} , and these were plotted against the corresponding times of development in Fig. 32B. The value of D_{∞} used is indicated on each curve. It is evident that a value still lower than $D_{\infty} = 2.00$ is required to produce a straight line over any range. Referring to the data obtained it is seen that this value for the density is reached after about three minutes' development, and is much exceeded later. The value 2.00 or less is therefore wrong, and when examined in detail the method is found not to apply. On plotting

values of $\log \frac{D_{\infty}}{D_{\infty} - D}$ against $\log t$, a very reasonable value,

$D_{\infty} = 2.80$, gives a straight line over the entire range observed. Fig. 32C shows this and the effect of using too high or too low values of D_{∞} . For the value $D_{\infty} = 2.80$, therefore, the relation is:

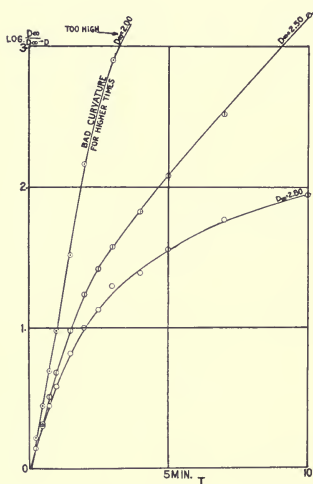

Fig. 32-B

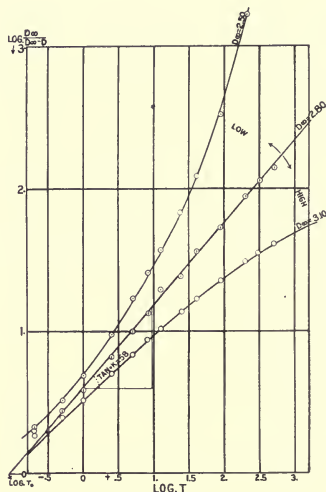

Fig. 32-C

$$K (\log t - \log t_0) = \log \frac{D_{\infty}}{D_{\infty} - D},$$

in which the constants are as follows:

$$\begin{aligned} K &= 0.58; \\ D_{\infty} &= 2.80; \\ \log t_0 &= -1.05; \\ t_0 &= .35. \end{aligned}$$

Putting the equation above in the exponential form $D = D_{\infty} (1 - e^{-k \log t / t_0})$, and computing densities by means of it, with the constants indicated, the points in Fig. 32a shown by black dots are obtained. This agrees very well with the results obtained. Obviously, it is unnecessary to go to the additional labor of computing densities, since the curve of $\log \frac{D_{\infty}}{D_{\infty} - D}$ plotted against $\log t$ indicates the nature of the agreement.

Several experiments, detailed in Table 15 show the possibilities of the values of D_{∞} as computed being reached on longer development.

TABLE 15¹

<i>T dev.</i> Min.	Special Emulsion	See 30				
	Experiment 108 Paraminophenol	Experiment 124 Pyrogallol	Experiment 126 Hydroquinone	Experiment 135 Monomethyl paraminophenol	Experiment 136 Toluhydroquinone	Experiment 140 Paraminophenol
	<i>D</i>	<i>D</i>	<i>D</i>	<i>D</i>	<i>D</i>	<i>D</i>
0.5	0	0.52	0	0.60	0.24	0.25
1	0.52	1.00	0.26	1.06	0.77	1.58
2	1.12	1.66	1.12	1.66	1.42	1.04
4	1.66	2.38	2.00	2.24	2.20	1.53
6	1.97	2.77	2.52	2.52	2.66	1.80
8	2.12	2.96	2.85	2.67	2.98	1.98
10	2.27	3.06	3.06	2.79	3.20	2.12
15	2.54	3.26	3.32	3.00	3.48	2.43
20	2.72	3.36	3.40	3.10	3.62	2.67
25	2.82	3.43	3.48	3.21	3.76	2.87
30	2.86	3.60	3.02
Computed <i>D</i> _∞	3.00	4.00	3.80	3.60	4.40	4.20

The values of D_{∞} appear very reasonable in all cases except perhaps the last two. However, the densities are still, after thirty minutes' development, increasing at a fair rate. In the last case (Experiment 140) the increase from the beginning is very gradual. There were isolated cases in which the difference between the highest observed density (usually after thirty minutes' development) and the computed D_{∞} was rather large. In general, the evidence is so strong that the few experiments giving such differences are thought to be either erroneous or exceptions due to relatively unimportant phenomena. The computed values are subject to an error of between five and ten per cent. Aside from this error there is that due to the difficulty of measuring high densities with accuracy, so that the observed densities for long times of development are less reliable. The lower densities cannot be used because of the fog error.

In the succeeding chapters the equation $D = D_{\infty} (1 - e^{-K \log t/t_0})$ will be applied in determining development characteristics, and it is considered that in addition to

¹ All developers M/20, with 50 grams of sulphite and 50 grams carbonate per liter.

the above, the data given there support this equation. This seems to be the simplest equation which can describe the development process with any degree of accuracy. No doubt it will be possible to find a more accurate expression, but this will involve the use of correction factors or constants unknown at the present time, as in Sheppard's equation (equation 20, page 79). The use of one more constant than contained in our equation above necessitates separate experimental work for the determination of the new constant or one of the others.

The following form has been suggested:

$$D = D_{\infty} (1 - e^{-K(t-t_0)^b}). \quad (30)$$

For X-ray exposures and in certain other cases this was found of somewhat wider application than the form we have used. But it contains an additional constant b , which requires that one of the constants be determined by experiment. t_0 will be most convenient, since it represents the abscissae of the intersection of the $D-t$ curve with the time axis. Equation 30 becomes, in the log form

$$\log K + b \log (t - t_0) = \log \log \frac{D_{\infty}}{D_{\infty} - D}, \quad (31)$$

from which is obtained

$$\frac{dD}{dt} = Kbt^{b-1} (D_{\infty} - D). \quad (32)$$

By use of equation 31 the constants may be evaluated.

$\log \log \frac{D_{\infty}}{D_{\infty} - D}$ is plotted against $\log t$ for a straight line in a

manner analogous to that already used. The slope of this straight line is b , and the ordinate at $\log t = 0$ will be $\log K$; t_0 is obtained as indicated above. The entire process is somewhat more lengthy than desirable.

Twenty or more cases of widely different character were computed by both equation 28 (Nietz) and equation 30 (Wilsey). The following table gives the results of the comparison, the experiments with bromide added to the developer being withheld for the time being.

In Experiments 132 and 145, 50 gm. of sulphite per liter were used, as before, but no sodium carbonate. The concentration of the developing agent was M/20. The emulsion used was Seed 30. All the computations are for the standard exposure.

TABLE 16

Experiment Number	Developer	(Wilsey)			(Nietz)	
		D_{∞}	K	b	D_{∞}	K
129	Dichlorhydroquinone.....	3.60	.50	.42	3.60	.53
130	Paramethylamino orthocresol sulphate	4.00	.65	.32	4.00	.60
132	Paraphenylene diamine hydrochloride (no alkali).....	1.60	.08	.78	1.78	.34
135	Monomethylparaminophenol sulphate.....	3.60	.49	.47	3.60	.58
137	Paramino methylcresol hydrochloride	4.00	.28	.62	4.00	.72
145	Diaminophenol hydrochloride (no alkali).....	3.60	.36	.52	3.60	.55
133	Dibromhydroquinone	3.80	.39	.46	3.80	.68
136	Tolhydroquinone	4.00	.28	.74	4.40	.63
144	Bromhydroquinone.....	3.40	.35	.72	3.80	.66
140	Paraminophenol hydrochloride	4.20	.23	.50	4.20	.30

These results show that the two equations yield practically the same value for the equilibrium constant D_{∞} . As would be expected, K varies widely in some cases, Wilsey's constant b influencing the variation. t_0 is not recorded as it is determined experimentally in Wilsey's method and in the other is an empirical constant larger than the observed t_0 . Wilsey's equation has the advantage that, although more complex and therefore more cumbersome, it more nearly describes the development process from beginning to end. It generally gives nearly the same values for D_{∞} as the form $D = D_{\infty} (1 - e^{-K \log t/t_0})$ and in addition fits the beginning of the reaction somewhat better (beyond a small initial period of acceleration). In the experiments detailed in Table 16, equation 30 fitted the data from two or three minutes on, as a rule. It is somewhat difficult to attach much physical significance to the constants of this equation.

CONCLUSIONS

In Table 17 the various velocity equations under discussion are summarized. In brief, the findings for each case are:

I. The simple form describes the early stages of the reaction, and these only under limited conditions. It is necessary that the time of appearance be very short and that the reaction be one which does not damp itself quickly—i. e., does not proceed rapidly to nearly its maximum. A density-time curve of nearly hyperbolic form (such as often given by monomethylparaminophenol sulphate and paraminophenol hydrochloride) cannot be fitted except for a very short range of time.

TABLE 17

FORMS OF VELOCITY EQUATION USED

	Log Form	Exponential Form	First Derivative = Velocity	Author
I	$Kt = \log \frac{D_\infty}{D_\infty - D}$	$D = D_\infty (1 - e^{-Kt})$	$\frac{dD}{dt} = K (D_\infty - D)$	Applied to Photographic material by Sheppard and Mees.
II	$K (t - t_0) = \log \frac{D_\infty}{D_\infty - D}$	$D = D_\infty (1 - e^{-K(t-t_0)})$	$\frac{dD}{dt} = K (D_\infty - D)$	Correction applied to I by Sheppard.
III	$K (\log t - \log t_0) = \log \frac{D_\infty}{D_\infty - D}$	$D = D_\infty (1 - e^{-K \log t / t_0})$	$\frac{dD}{dt} = \frac{K}{t} (D_\infty - D) = K t^{-1} (D_\infty - D)$	Nietz.
IV	$\log K + b \log (t - t_0) = \log \log \frac{D_\infty}{D_\infty - D}$	$D = D_\infty (1 - e^{-K(t-t_0)^b})$	$\frac{dD}{dt} = K b t^{b-1} (D_\infty - D)$	Wilsey (applied to X-Ray Sensitometry)
V	$Kt = \log \frac{p \xi}{p \xi - D} - \frac{d}{(d+h)(D_\infty - p \xi)} \log \frac{D_\infty}{D_\infty - D}$		$\frac{dD}{dt} = K \frac{b-aD}{h(D_\infty - D)} + d (D_\infty - D)$	Sheppard

In the latter $p \xi$ corresponds to D_∞ as used in the first four, while D_∞ represents the mass (unknown) of the latent image.

II. Much more satisfactory than I, but not generally applicable, it nearly always fails to fit the data in the later stages. This indicates that photographic development shows, after a time at least, departures from the first order reaction law.

Equation II is useful especially in the determination of t_0 , which, computed by this equation, is practically the time of appearance and gives more reliable results than could be obtained by the visual method.

III. This equation is of general application. It fits practically all cases beyond the initial stage and is easily applied to the data. t_0 is an empirical constant. In some experiments equation III yields values of D_∞ which are quite high compared with those observed on long development, but it is quite possible that development continues for hours. Experimental verification of the value of the maximum density was obtained in nearly all cases. In some doubtful experiments development probably was not long enough and the densities obtained were too high to permit of accurate measurement.

The fact that equation III indicates that the velocity is inversely proportional to the time is not satisfactorily explained. The writer assumes that various complex phenomena affect the result in such a way that $1/t$ in the velocity equation represents a close approximation to the real function. Further study would be required to determine the true relation.

For general comparisons equation III is believed to be quite the most satisfactory form from the standpoint both of convenience and of accuracy.

IV. Equation IV sometimes holds over a wider range than equation III and is generally equally satisfactory, though it is not so easily applied. One of the constants must be determined experimentally, and doing this for t_0 simplifies the method. As an empirical expression this form most accurately describes the relation between time of development and density developed.

V. Equation V cannot be applied because of the large number of unknown factors involved.

Glancing down the column marked "First Derivative," in Table 17, it is seen that the velocity function has been made more and more complex. More correction factors have been applied to account for the phenomena occurring. No doubt we should find if we could apply equation V that it would fit the data more perfectly than the preceding forms, as the corrections are larger in number. Equation V was deduced

for development with ferrous oxalate by the use of certain simplifying assumptions.

For alkaline development, which is so much more complex, any number of other involved equations might be set up, none of which would be more than a purely empirical expression. Since either equation III or equation IV supplies the need, and apparently gives a reliable indication of the end-point of the reaction, it seems justifiable to apply them to the data obtained.¹

¹ Since this was first written, an equation based on the inclusion of terms for a paralysing action of reaction products has been developed by Sheppard (*Phot. J.*, **59**: 135. 1919) and is now being investigated.

CHAPTER VI

VELOCITY OF DEVELOPMENT (*Continued*)

Maximum Density and Maximum Contrast and their Relation to Reduction Potential and other Properties of a Developer

CHARACTERISTICS OF THE VELOCITY EQUATION

The character of the velocity equation

$$D = D_{\infty} (1 - e^{-K \log t/t_0})$$

is more or less evident from inspection of the exponential and logarithmic forms and of the derivative, but the interpretation of these into photographic results is not so clear. For this reason a brief analysis is made. If $t = t_0$, $D = 0$. When $t = \infty$, $D = D_{\infty}$. The factor $(1 - e^{-K \log t/t_0}) = \frac{D}{D_{\infty}}$ and therefore expresses the fraction developed at the time t .

The effect of changing each of the three variables, K , t_0 and D_{∞} , one at a time, is as follows:

The higher the value of K , the greater the density in the time t , and the greater the fraction developed.

For variable t_0 , the fraction developed at a given time becomes less with increasing t_0 . The entire curve ($D - t$) is shifted, each density being displaced horizontally by the increase in t_0 . Hence the density produced in a given time is decreased if t_0 is increased.

Increasing D_{∞} produces greater density in a given time of development. The fraction developed is always the same for equal times.

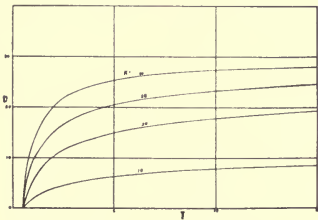

D-t curves $K = .10$ (bottom),
.30, .50, .80

Fig. 33

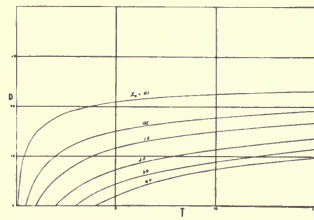

D-t curves for $t_0 = .1, .5, 1.0,$
2.0, 3.0 and 4.0 (bottom)

Fig. 34

These relations are shown respectively by Figs. 33, 34, and 35.

The logarithmic form $K (\log t - \log t_0) = \log \frac{D_\infty}{D_\infty - D}$ shows obvious relations already described.

The derivative is

$$\frac{dD}{dt} = \frac{K}{t} (D_\infty - D).$$

For the curve in Fig. 34, where $t_0 = 1.0$, $K = 0.3$ and $D_\infty = 3.0$, the velocity varies with time as shown by the continuous line in Fig. 36, in which the ordinate is $\frac{dD}{dt}$ or the velocity.

These values represent a typical case. In practice there is the period of induction, shown by the dotted line.

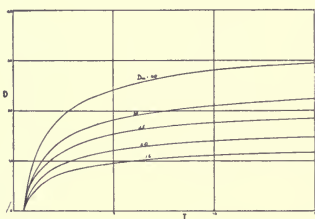

D-t curves for $D_\infty = 1.6$ (Bottom),
2.0, 2.5, 3.0 and 4.0
Fig. 35

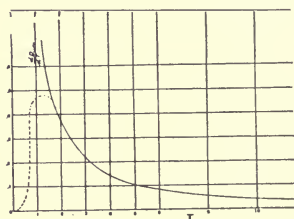

Velocity curve
Fig. 36

One of the chief characteristics of this equation is the length of time required to reach nearly complete development. For example, in Fig. 35 the fractions developed are as follows:

t	$(1 - e^{-K \log t/t_0}) =$ fraction developed
2 min.	.43
4 min.	.57
6 min.	.63
8 min.	.67
10 min.	.70
15 min.	.74

The time required for a definite fraction to be developed may be found by equating $(1 - e^{-K \log t/t_0})$ to the desired fraction, inserting the values of K and t_0 and solving for t . For any fraction a the time $t = t_0 e^{\frac{-1}{K} \log \frac{1}{1-a}}$. For the theoretical curve in Fig 34 ($t_0 = 1.0$, $K = 0.3$, and $D_\infty = 3.0$), for

which the velocity curve is shown in Fig. 36, the time for ninety per cent development is accordingly $t_0 e^{\frac{2.30}{K}} = (1.0) e^{\frac{2.30}{.3}} = 2,140$ minutes. The higher the value of K and the lower the value of t_0 , the shorter the time required. In most cases the time for ninety per cent development varies from thirty minutes to two or three hours.

DETAILS OF THE EXPERIMENTS

The procedure has already been outlined. The density-time curves secured for a standard value of the exposure (standard log E) were such that in all cases the densities lay well up on the plate curve. Other results showed that under these conditions the fog error is eliminated. In general, the density-time curve for these conditions gives the most reliable photographic data which can be secured. It is, of course, affected by any erratic behavior of the developer, but usually less so than other data for the same emulsion and developer.

In all cases the times of development ranged from that necessary to produce the first visible density to at least 15 minutes and, in the majority of cases, 25 to 30 minutes or more. As a rule the values of the constants D_∞ , K , and t_0 were found for the particular equation which fitted the data over the maximum range from the longest observed time back toward the beginning. In most cases there was little doubt as to these values. The average error in drawing a new curve and recomputing D_∞ , or in a repetition of the experiment with an ordinary developer and emulsion, is between five and ten per cent. In some cases the developer or the emulsion or both reacted in unusual ways, and the results were of little value. We believe the results given below to be as accurate as any it is possible to secure under like conditions.

VARIATION OF MAXIMUM DENSITY WITH EXPOSURE

If the density-time curves are drawn for different values of log E for a given developer and emulsion and the maximum density computed for each, different values of D_∞ result which, plotted against the logarithms of the corresponding exposures, give a new plate curve for the equilibrium condition. This is illustrated in Fig. 37. Each point represents a computation of D_∞ from a density-time curve at the indicated log E value. The point M can be determined separately by methods already explained, it representing the common inter-

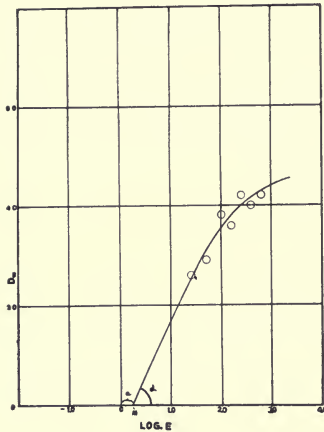

Fig. 37

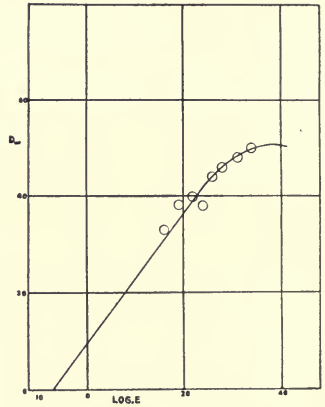

Fig. 38

section point of the H. and D. curves for the given conditions. In Fig. 37 the curves intersect on the $\log E$ axis as usual, and the value of a (the $\log E$ coordinate of the point of intersection) is 0.12. Consequently a straight line or plate curve may be drawn from M through the series of maximum densities, as shown. Increasing fog error prevents the locating of more points for the lower $\log E$ values. From other information and a consideration of the plate curves it does not seem logical to take a value of $\log E$ much lower than 1.4.

The curve shown is for M/20 paraminophenol hydrochloride on a Seed 30 emulsion. a was determined from a number of experiments, using various concentrations of bromide.

Fig. 38 represents a similar result from M/20 dibromhydroquinone on a fast emulsion. Here a is obtained from but one determination with no bromide, and, therefore, is not so accurate as the preceding value.

Such experiments show that within reasonable limits, the plate curve for infinite development may be drawn. Also, this method increases the accuracy of the determination of D_∞ at any particular value of $\log E$.

MAXIMUM CONTRAST (γ_∞) AND A NEW METHOD FOR ITS DETERMINATION

It is impossible to treat separately and in a definite order all phases of the present problem. For convenience in presenting the data, the maximum contrast, γ_∞ , will be discussed here.

This term (γ_∞) requires careful interpretation. γ_∞ is the theoretical contrast reached on infinite development, or the slope of the plate curve when development has reached equilibrium. In practice this is never attained, since all developers and emulsions give appreciable fog on prolonged development, and the fog is greater the lower the density of the image. Hence the lower portion of the straight line of the plate curve in Fig. 38 will be raised by fog, the contrast thus being lowered. But the image tends to give the contrast indicated by the lines in Figs. 37 and 38 and this value is the characteristic constant for the given condition. The highest contrast which can be obtained practically will be reached at some intermediate time and will then decrease, the maximum being always lower than γ_∞ as defined. Fig. 39 shows these

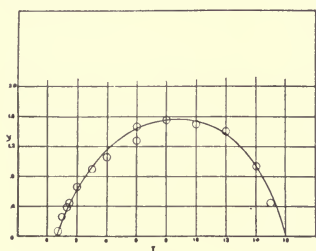

Fig. 39

relations for a developer giving bad fog on prolonged development. γ_A is the contrast obtained. At about eight and one-half minutes' development γ_A is nearly equal to γ_∞ , which was found by the method described below. The developer used was M/20 hydroquinone without bromide. With certain developers, and always when bromide is used, the

maximum value of γ_A may continue for a long time, the period of decrease being delayed. Thus over an observed range of ten to fifteen minutes the $\gamma - t$ curve may be an exponential of the same type as the $D - t$ curve.

Where it is possible to draw the curve for the plate at maximum development, as in Figs. 37 and 38, γ_∞ can be determined from the slope of the straight line. If this can not be done, it may be computed as follows: The relation between density and gamma was expressed as

$$D = \gamma (\log E - a) + b.$$

From data on the $D - \gamma$ relation, especially with bromide, where upon prolonged development γ_∞ is closely approached, there is every reason to believe that this relation holds at the limit;—that is,

$$D_\infty = \gamma_\infty (\log E - a) + b; \tag{33}$$

from which

$$\gamma_\infty = \frac{D_\infty - b}{\log E - a}. \tag{34}$$

Consequently, γ_{∞} may be calculated if D_{∞} is known (from a velocity curve at some particular value of $\log E$) and the values of a and b are also known. In the complete study of an ordinary developer all these can be determined with a fair degree of accuracy.

In Fig. 38, for example, the value of D_{∞} at $\log E = 2.4$ is 4.20, $b = 0$, and $a = -0.60$. Therefore, $\gamma_{\infty} = \frac{4.20}{2.40 + 0.60} = 1.40$, which the figure also shows.

In Fig. 37, $\log E = 1.8$ (on the straight line portion). $D_{\infty} = 3.20$, $b = 0$ and $a = 0.12$. Therefore, $\gamma_{\infty} = \frac{3.20}{1.80 - 0.12} = 1.92$.

As previously stated, D_{∞} is usually determined more accurately than a . Hence the accuracy of γ_{∞} is governed largely by the accuracy of a . In Fig. 37, a is well determined. In Fig. 38 it is the result of but one set of observations.

Some advantages of the above method, as well as its further applications, are discussed in a later chapter. (See Chapter X.)

VARIATION OF D_{∞} AND γ_{∞} WITH THE DEVELOPER

From the chemical standpoint D_{∞} is more important than γ_{∞} , as a constant, the latter being merely a consequence of the former and of the relative location of the intersection point of the plate curves. From the photographic standpoint γ_{∞} and the maximum value of γ_A are of greater importance, as they are more obvious indicators of the character of the emulsion and of the developer. In the present instance we are interested mainly in the relations for the density at equilibrium, though results for the contrast are included.

As a result of the experimental work, the view that the inertia point, the value of D_{∞} for fixed exposure, and γ_{∞} are fundamental constants of an emulsion must be abandoned. It has been shown that the inertia may change with the developer. Sheppard and Mees also found this, but did not find the variation great, few developers being used. Aside from the work of Sheppard and Mees, very little has been done on the relations of D_{∞} and γ_{∞} as here considered. There is no doubt that some developers can reduce more silver for the same exposure, and to greater or less degrees of contrast, than others. Consequently, D_{∞} and γ_{∞} are not fixed constants

for an emulsion. They may be used as such only when a certain developer is used, the variations then being assumed as due to the emulsion.

The available evidence on these equations is given below. It is quite conclusive in many respects, and the continual recurrence of certain relations throughout the work strengthens the hypotheses.

In the following results D_{∞} and K were found by means of the equation $D = D_{\infty} (1 - e^{-K \log t/t_0})$ applied to the $D - t$ curve for a fixed exposure. a and b were found from $D - \gamma$ curves for the same exposure, and γ_{∞} was then computed from equation 34.

Experimental conditions were constant for each set.

Table 18 gives the results of experiments on an ordinary emulsion of medium speed. Values of the reduction potentials (π_{Br}) of the developers as previously found, are included for convenience.

TABLE 18

DEVELOPER		π_{Br}	D_{∞}	γ_{∞}
M/25	Bromhydroquinone	21	3.7	2.29
- M/20	Monomethylparaminophenol sulphate ...	20	3.9	2.33
M/20	Chlorhydroquinone	7	2.7	1.62
M/20	Paraminophenol hydrochloride	6	3.2	1.99
M/20	Tolhydroquinone	2.2	3.3	1.75
M/20	Paraphenyglycine	1.6	2.8	1.55

It is evident here that the maximum density D_{∞} and the maximum contrast γ_{∞} show a marked tendency to increase with increasing reduction potential. It was concluded from these data that the relation would hold, but further work showed exceptions to the rule. Hydroquinone, for example, though a developer of high bromide sensitiveness, (i. e., low reduction potential), can produce high maximum density and contrast. Consequently, as before when an attempt was made to give a classification on the basis of reduction potential, these exceptions show that the reduction potential is not always the chief governing characteristic. But we believe that the reduction potential often conditions the result, and that the general trend is in the direction of the results shown in Table 18.

Table 19 gives the results of four developers of Special Emulsion IX, a fast ordinary emulsion on patent plate glass.

TABLE 19

DEVELOPER		π_{Br}	D_{∞}	γ_{∞}
M/20	Pyrogallol.....	16	3.90	1.71
M/20	Dimethyl paraminophenol sulphate	10	2.80	1.47
- M/20	Paraminophenol hydrochloride	6	3.00	1.40
- M/20	Paraphenyglycine	1.6	3.40	1.32

Table 20 gives the data from twenty experiments on emulsions for some of which the speed data are given in Table 10, Chapter IV. The results from three developers in Table 19 are included.

TABLE 20

Variation of D_{∞} , γ_{∞} and K with emulsion and developer
 I M/20 Pyrogallol
 II M/20 Dimethylparaminophenol sulphate
 III M/20 Paraminophenol hydrochloride

EMULSION	I			II			III		
	D_{∞}	γ_{∞}	K	D_{∞}	γ_{∞}	K	D_{∞}	γ_{∞}	K
Special Emulsion IX.....	3.90	1.71	.53	2.80	1.47	.64	3.00	1.40	.58
Special Emulsion VIII.....	3.50	3.58	.31	2.50	3.30	.36	2.10	1.98	.33
Special Emulsion XII.....	3.60	1.90	.65	2.80	1.76	.45	3.15	1.85	.50
Special XIII.....	4.00	5.7	.31	4.00	5.9	.34	3.50	5.6	.21
Emulsion 3533.....	4.00	1.22	.57	3.20	1.18	.61	4.20	1.84	.40
Special Bromide XIV.....	5.00	5.9	.38	3.6031	3.70	3.40	.26
Film Special Emulsion XV.....	2.80	1.84	.27	2.60	2.00	.56
π_{Br}	16			10			6		

In analyzing the table and comparing the results it is seen that of the three developers at the same concentration, pyrogallol can reduce the most silver for the same exposure. This is an indication that on the average it probably develops greater theoretical contrast. M/20 paraminophenol hydrochloride on Emulsion 3533 seems to be an exception to both rules. The relation between paraminophenol and dimethylparaminophenol is somewhat indefinite. These developers are nearer each other in reduction potential than is the higher to pyrogallol, and they resemble each other in chemical properties to a much greater extent than either resembles pyrogallol. Consequently the above results are not surprising. Other results to be given below show that developers differing widely in their chemical nature generally develop to different degrees, but that compounds which react similarly do not differ much in this respect.

To test this hypothesis further equivalent concentrations of a number of reducing agents were used on the same emulsion. In Table 21, these are arranged in order of D_{∞} , beginning with the highest. If two developers give the same D_{∞} , the

one with the higher K and lower t_0 is placed first, it being assumed that in general the faster is the more powerful. Values of D_∞ , γ_∞ , K , and t_0 are included.

TABLE 21

Different developers on the same emulsion,¹ arranged according to values of D_∞

M/20	DEVELOPER	D_∞	π_{Br}	γ_∞	K	t_0
	Tolhydroquinone.....	4.40	2.2	1.67	.63	1.35
	Diaminophenol plus alkali*....	4.2	40.	1.40	.60	0.6
	Paraminophenol*.....	4.2	6.	1.84	.44	1.0
	Paramino-metacresol.....	4.0	9.	1.33	.72	1.24
	Methylparamino-orthocresol...	4.0	23.	1.26	.60	.33
	Pyrogallol*.....	4.0	16.	1.22	.57	0.78
	Chlorhydroquinone*.....	4.0	7.	1.82	.52	1.3
	Hydroquinone*.....	3.8	1.	1.26	.95	1.80
	Dibromhydroquinone.....	3.8	8.	1.27	.80	0.80
	Paramino-orthocresol.....	3.8	7.	1.27	.70	0.87
	Bromhydroquinone.....	3.8	21.	1.73	.66	1.27
	Eikonogen.....	3.8	1.43	.47	1.7
	Monomethylparaminophenol*..	3.6	20.	1.50	.58	.70
	Diaminophenol, no alkali.....	3.6	1.63	.55	.36
	Pyrocatechin.....	3.6	1.68	.52	.60
	Dichlorhydroquinone.....	3.6	11.	1.29	.53	.80
	Edinol.....	3.6	1.22	.46	1.9
	Phenylhydrazine, no alkali.....	3.5	1.003	8.5
	Dimethylparaminophenol.....	3.2	10.0	1.18	.61	0.75
	Ferrous oxalate*.....	3.1	0.3	1.29	.55	0.97
	Benzyl paraminophenol (Duratol).....	2.4	less than 5	0.98	.34	2.27
	Paraphenylene diamine.....	1.7	0.4	0.58	.34	2.10

Of the developing agents in Table 21, those marked with an asterisk were of high purity, the others, excepting Edinol, Duratol, and Eikonogen, which were the commercial product, were somewhat better than commercial purity.

This table does not by any means show that D_∞ always varies with the reduction potential, if the latter as previously measured is considered. But by this method, developers may be compared on a basis which is more or less independent of the observer, the degree of development, and numbers of special factors, and it is quite certain that several definite tendencies are indicated. These may be summarized as follows:

¹ Seed 30 Emulsion 3533

D_{∞} and γ_{∞} for a single emulsion may vary greatly with different reducing agents.

The value of the equilibrium density, D_{∞} , tends to be greater the higher the reduction potential of the developer. Exceptions to this rule may be accounted for in a number of ways, on none of which there is definite information. (See effect of sulphite on the maximum density obtained with hydroquinone, Chapter IX.)

γ_{∞} shows an unordered variation with any of the properties of the reducing agents. The lowest values are obtained for developers of the lowest reduction potential, but this relation does not hold with higher values. The intersection points of the H. and D. curves show similar unsystematic shifting. Because the speed of the plate is a function of some other property than the reduction potential of the reducing agent, γ_{∞} is also. For developers giving about the same plate speed, γ_{∞} tends to be higher with increasing potential.

The unsubstituted aminophenols stand at the head of the list in Table 21, next the hydroxybenzenes and their halogen substitution products, and the amines are at the bottom.

Hydroquinone and its mono- and dichlor- and brom-substitutions seem to be nearly identical in this classification, though their reduction potentials vary greatly. This may be because the mechanism of their oxidation is the same, and that other conditions also are similar, these masking any effect of reduction potential.

Most cases which show a systematic variation of D_{∞} with reduction potential also show systematic variation in what is erroneously termed the "rapidity"—that is, the time required to develop a definite intermediate density. If, for example, we note the densities developed in, say, two minutes for each case, these will tend to be in the same order as the values of D_{∞} . This is evident from the character of the equation $D = D_{\infty} (1 - e^{-K \log t/t_0})$, (see also Fig. 35), since if K and t_0 are nearly constant the density for a fixed time will vary with D_{∞} . From the data given it will be seen that the variation in K is not great and that for many compounds t_0 also does not vary widely. Some of these facts will be clearer from the following discussion.

The analogy of the relations to Ohm's law may be roughly illustrated by the experiments detailed in Table 21. Of course we should not expect this relation to hold with any accuracy since velocity is not usually a reliable measure of

potential, but the fact that it gives even approximately the right order for the developers below, as we know them, is interesting indirect evidence. By analogy

$$\text{Velocity} = \frac{\text{Potential}}{\text{Resistance}}$$

or

$$\text{Potential} = \text{Velocity} \times \text{Resistance.}$$

According to Nernst and others the principal factors of the resistance here are the diffusion phenomena. For two developers used on the same emulsion, where the period of retardation, shown by t_0 , and the velocity constant K are each the same for both cases, the diffusion effects and minor factors of the resistance may quite reasonably be assumed to be equal. Hence the potentials will be directly proportional to the velocities for these conditions, or

$$\frac{\text{Potential}_x}{\text{Potential}_{\text{Std.}}} = \frac{\text{Velocity}_x}{\text{Velocity}_{\text{Std.}}} = \frac{\frac{dD}{dt}_x}{\frac{dD}{dt}_{\text{Std.}}} = \frac{\frac{K}{t} (D_\infty - D)_x}{\frac{K}{t} (D_\infty - D)_{\text{Std.}}}$$

Taking the velocities at the time t in both cases gives us for

$$\text{the above } \frac{K (D_\infty - D)_x}{K (D_\infty - D)_{\text{Std.}}}. \text{ If } K_x = K_{\text{Std.}} \text{ the equation would}$$

be further simplified, but we have no instances in which this relation is more than approximately true. Consequently in the table below the developers are grouped according to equal retardation times and are intercompared by the ratios of the velocities. No more data were available for this comparison, as it is necessary to have both t_0 and K the same for the different developers. The values given are for the developers and the emulsions referred to in Table 21. All velocities are computed for two minutes from the derivative of $D = D_\infty (1 - e^{-K \log t/t_0})$, - i. e., $dD/dt = (K/2) \cdot (D_\infty - D)$.

TABLE 22

Relative Reduction Potentials, Computed by Comparison of Velocities for Equal Resistances

$$\frac{\text{Potential}_x}{\text{Potential}_{\text{Std.}}} = \frac{dD/Dt_{\text{for } x}}{dD/dt_{\text{for Std.}}}$$

All developers M/20 except ferrous oxalate, which is M/10.

DEVELOPER	t_0	K	D_∞	After 2 minutes	Velocity at 2 minutes	Relative Potential
Pyrogallol.....	.78	.57	4.00	1.27	.67	13
Dimethylparaminophenol.....	.75	.61	3.20	1.48	.52	Std. = 10
Dichlorhydroquinone.....	.80	.53	3.60	1.38	.59	11
Ferrous oxalate.....	.97	.55	3.10	0.70	.66	5.7
Paraminophenol.....	1.00	.44	4.20	1.04	.70	Std. = 6
Dibromhydroquinone.....	.80	.80	3.80	1.38	.97	8
Paramino-orthocresol.....	.87	.70	3.80	1.40	.84	Std. = 7
Paramino-metacresol.....	1.24	.72	4.00	1.30	.97	9.5
Chlorhydroquinone.....	1.30	.52	4.00	1.24	.72	Std. = 7
Tolhydroquinone.....	1.30	.63	4.40	1.42	.94	7
Bromhydroquinone.....	1.27	.66	3.80	1.36	.81	8.4

The comparison is by groups, in each of which the conditions are approximately fulfilled.

Arranging these values in order and comparing them with those previously found by the depression method gives the results in Table 23.

TABLE 23

Relative Reduction Potentials

	From velocity ratios	From previous data
Pyrogallol.....	13	16
Dichlorhydroquinone.....	11	—*
Dimethylparaminophenol.....	10	10
Paramino-metacresol.....	9.5	—*
Bromhydroquinone.....	8.4	21
Dibromhydroquinone.....	8	—*
Paramino-orthocresol.....	7	7
Chlorhydroquinone.....	7	7
Tolhydroquinone.....	7	2.2
Paraminophenol.....	6	6
Ferrous oxalate.....	5.7	0.3

Although the above values are not entirely consistent, there is reasonable evidence that the assumptions of equal resistance are approximately correct, and that for such cases the velocities calculated from the velocity function are a measure of the potentials. There is further evidence that a developer of

* Not determined

lower reduction potential reduces less silver. If bromide is added to a developer, its reduction potential is lower than if no bromide were present; and as its potential is lowered (more bromide is added) the maximum amount of work it can do, measured by the equilibrium density, D_{∞} , decreases. The systematic variation of D_{∞} with the reduction potential under these conditions is easily understood, as no doubt the complicating factors which vary from one developer to another are constant here. Resistance factors due to addition of bromide are evident only in a change in t_o , not in K , as will be shown later.

It seems quite probable that in many cases, comparing the velocities gives a rough measure of the reduction potential, and that the classification according to the values of the equilibrium point alone furnishes information in this direction. We should expect the more powerful developer to drive the reaction farther in the presence of its oxidation product. If, however, the oxidation products are removed by side reactions, or if other physical or chemical factors exert control over the development process, the end point and the velocity become a false measure of the energy. This is probably what occurs with hydroquinone and some of its substitution products, causing them to develop as much density finally as monomethylparaminophenol, for example.

THE LATENT IMAGE CURVE

If different amounts of silver can be reduced by different developing solutions, what determines the limit to which the process can go? Can the latent image be fully developed? To these questions a definite answer can not yet be given. It is not possible at present to determine the quantity of latent image present in an emulsion which has been affected by a definite quantity of energy. However, a few generalizations concerning the relations between the developer and the quantity of latent image developed may be given.

The grain is considered the unit of the latent image. If a single nucleus exists in the grain, the latter is developable. That is, it requires photochemical change of but one molecule to render the entire mass of the grain capable of reduction. The grain may contain any number of nuclei. Consequently different emulsions, even of the same speed, may possess entirely different numbers of developable grains (per unit area) for the same exposure, and the relation between the number of developable grains and the exposure may vary with

the latter. Therefore, the only logical measure of the latent image is the number of nuclei formed per unit area; but the measure of the effective latent image, or of the reducible halide as understood here must be the number of developable grains. The only way the latent image manifests itself is by reduction to metallic silver. The result of this process may be studied in its relation to the energy received by the emulsion, and this relation Hurter and Driffield deduced and expressed in the form mentioned earlier in this monograph. But this throws no light on the questions under consideration.

It is conceivable that grains containing more nuclei are more susceptible to development, though this point is open to dispute. However, if this were true, it would afford an easy explanation of the fact that more energetic developers reduce more silver. Some of the grains, being of different susceptibility, or of different oxidation potentials, would be reduced by a developer of one reduction potential, while for other grains the potential required would be higher. Accordingly with different developers there would be a kind of sorting process, each developer reducing what it could, the one of highest reduction potential finally reducing the largest number of grains.

Under these conditions the latent image would be considered as never fully developed. That is, referring to Fig. 40, for $\log E_1$, developer I produces $D_{\infty 1}$, developer II, of higher reduction potential, reduces $D_{\infty 11}$, and developer III develops to the density $D_{\infty 111}$.

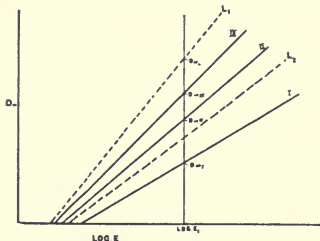

Fig. 40

But III does not necessarily develop all the grains; so it would be assumed that the limit of developability should be represented by D_L , and the latent image curve would lie above any actually obtained. Its straight line portion is indicated in the figure as the dotted line L_1 .

In the discussion of equation 20 in Chapter V, it was stated that $p\xi$, the equilibrium value of the density, D_{∞} , tends to approach the limit represented by the density of the latent image fully developed, depending on conditions. The latter, mentioned elsewhere, include all the complex phenomena of development. But nothing has been said as to the direction from which $p\xi$ (D_{∞}) approaches D_L . It is possible that, as the complicating factors are eliminated from the development

process, the limit D_L may be approached from either direction. Or it may be said that some developers (perhaps most), develop more density than that corresponding to the latent image, and others less. Perhaps it will be possible to find an "ideal" developer which will reduce, grain for grain, all of the latent image. This hypothesis of course rests upon the assumption that there is considerable reduction due to contamination and autocatalysis, and to physical development. Apparently there is no definite proof that development by contamination—i. e., reduction of a grain adjacent to one rather fully exposed and undergoing development—takes place¹. However, this might be possible, provided the grains are sufficiently close together, if it is assumed that a single nucleus makes a grain developable. That some false nuclei (nuclei not formed by light) are present and promote growth of the silver deposit is more than likely, and that physical development takes place to some extent can not be doubted. It may therefore be supposed that the process of photographic development consists in building *on to* a skeletal framework of latent image nuclei, rather than in building *up to* the complete structure. This conception would account for the fact that so little energy in exposure is required to give visible density on development, the very small quantity of latent image being sufficient to initiate development, which spreads as it gathers velocity.

According to this assumption the latent image curve might lie, say, at L_2 , or still lower, and under most curves obtained. There would seem to be considerable indirect evidence in favor of this view.

¹ This question is under investigation in the Laboratory.—Ed.

CHAPTER VII

VELOCITY OF DEVELOPMENT (*Continued*)

The Effect of Soluble Bromides on Velocity Curves and a Third Method of Estimating the Relative Reduction Potential

THE GENERAL EFFECT OF BROMIDES ON THE VELOCITY AND ON THE VELOCITY CURVES

If the concentration of potassium bromide in a given developer is varied and density-time curves (velocity curves) are plotted at a fixed exposure for each concentration, the effect of the bromide after a sufficient concentration is reached consists in a depression of the density developed in a fixed time, and in a marked increase in the period of retardation at the beginning. Only typical cases may be cited. Fig. 41 gives the velocity curves for M/20 paraminophenol on Emulsion 3533, with three concentrations of bromide. The observed densities are not given, the curves being those put

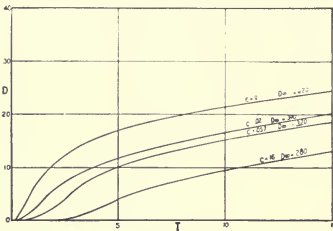

Fig. 41

through the observed points and the agreement being sufficiently good. Sixteen concentrations of bromide were used, with the results given in Table 31 (see page 87). Many similar experiments were carried out. The curves are for fifteen minutes' development only, whereas development was continued for thirty minutes.

The result shown in Fig. 41 is often masked if a developer which shows greater retardation with bromide is used (as for example, hydroquinone) or if development is stopped too soon. Consequently published results on the effects of bromide on the velocity are somewhat at variance with each other and with those recorded here. The present experimental work indicates definitely certain results which accord throughout with the illustrations given, these being among the best and clearest examples obtainable.

The curves show a marked parallelism for longer times. This suggests a depression of the curve, as for the plate curve, a subject to be treated later in this chapter. The values of D_∞ which are found from the equation $D = D_\infty (1 - e^{-K \log t/t_0})$ decrease with increasing bromide concentration, and the period of delay before development begins increases. The latter values, as indicated by the points on the time axis, were found by a special method briefly described on page 87. [Use of $D = D_\infty (1 - e^{-K (t-t_0)})$.]

As is to be expected, if the velocity is plotted against the time it is found that well beyond the period of retardation the velocity has not changed. Consequently, the effect of bromide on the velocity consists entirely of a change of velocity at the beginning (an increase in the retardation). This is shown in the four curves in Fig. 42, where the slope of the $D-t$ curves is taken as the velocity and plotted against the corresponding times. The initial period is roughly indicated.

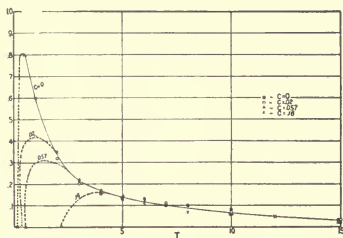

Fig. 42

VARIATION OF D_∞ WITH BROMIDE CONCENTRATION.
 A THIRD METHOD OF ESTIMATING THE RELATIVE
 REDUCTION POTENTIAL

The nature of the variation of the maximum or equilibrium density, D_∞ , with the bromide concentration has been noted. When D_∞ as determined for each concentration is plotted against the logarithm of the corresponding bromide concentration a straight line for a considerable range results. Typical cases for different emulsions and developers are illustrated. Some of these are from the data for the determination of the density depression, d , used in Chapter II, but not all of that material could be used here, as the density-time curves were not always obtained for a sufficiently wide range. Fig. 43 gives results,

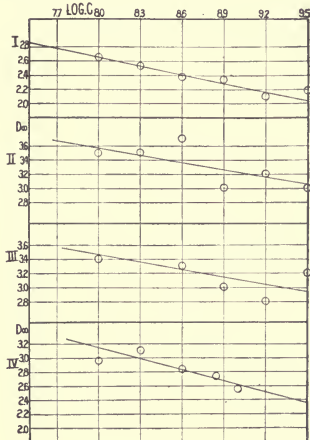

Fig. 43

for the four developers indicated, on Seed 23 emulsion of May, 1917, and Fig. 44 gives one curve for each, on different emulsions, as follows:

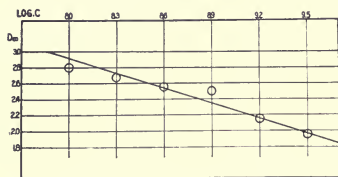

Fig. 44-A

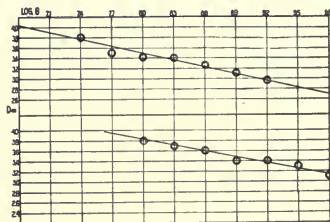

Fig. 44-B-C

Fig. 44A M/25 Bromhydroquinone on Pure Bromide II;

Fig. 44B M/20 Hydroquinone on Special Emulsion VIII;

Fig. 44C M/20 Dimethylparaminophenol on Special Emulsion IV;

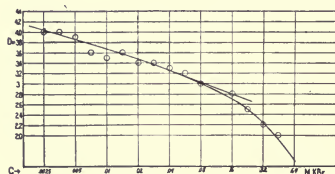

Fig. 45

Fig. 45 shows the most complete curve obtained, the data being for M/20 paraminophenol hydrochloride on Emulsion 3533, an ordinary fast emulsion.

Some of the curves shown are better than the average. Many of the less consistent cases may be explained by the

fact that it was not possible to secure a sufficient number of observations. All the data were treated as in the depression study, the observations being least-squared for slope and intercept after it was evident that a straight line function was under consideration.

Table 24 is an analysis of the results for the slope. It was found that the slope resembles that for the depression curves and the values of m , the slope of the d -log C curves as given in Chapter III, Table 4, which are repeated here for comparison. The slopes of the D_{∞} -log C curves are negative, a fact which may be ignored for the moment, the numerical values being of chief interest.

TABLE 24

Comparison of Slopes of D_{∞} -log C and d -log C Curves
Numerical Values of m

SEED 23 EMULSION OF MAY, 1917

	D_{∞} -log C	d -log C
Bromhydroquinone.....	$m = .34$	$m = .20$
Monomethylparaminophenol.....	.41	.28
Toluhydroquinone.....	.56	.52
Paraminophenol.....	.54	.36
Chlorhydroquinone.....	.40	.50
Hydroquinone.....	.82	.80
Average.....	.51	.44

PURE BROMIDE EMULSION, II

Bromhydroquinone.....	.48	.28
Chlorhydroquinone.....	.38	.38
Paraphenyglycine.....	.66	.70
Average.....	.51	.45

SEED 23 EMULSION OF JUNE, 1919

Ferrous oxalate.....	.35	.54
Hydroquinone.....	.44	.98
Paraphenyglycine.....	.36	.87
Average.....	.38	.80

SEED 30 EMULSION OF JULY, 1919

Paraphenyglycine.....	.50	.54
Pyrogallol.....	.54	.42
Dimethylparaminophenol.....	.40	.46
Average.....	.48	.47
Average for four emulsions.....	.47	.54
Mean of thirty cases.....	$m = .50$	

The data summarized in the table make it appear probable that the slope of the D_{∞} -log C curve is always the same and equal to the slope of the depression curve. Wide variations occur in relatively few cases; of thirty determinations, fifteen lie within twenty per cent of the mean and six more within thirty per cent. (It is difficult to attain greater accuracy under the conditions.) m is therefore accepted as the fundamental constant expressing the rate of change of the equilibrium point with the logarithm of the bromide concentration, and, at the same time, the rate of lowering of the intersection point of the plate curves. The further bearing of these facts and other evidence from the table will be discussed in a following section.

A new relationship for the maximum density, analogous to that for the density depression, may now be formulated. In Fig. 46 I and II are the $D_{\infty} - \log C$ curves for the developers I and II used on the same emulsion. The slope of each = $\tan \phi = -m$ (m being considered positive) = -0.50 (as found above). In general

$$D_{\infty} = -m (\log C - \log C'_0), \quad (35)$$

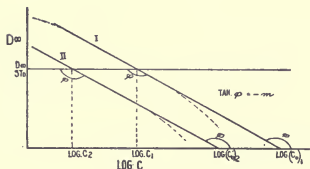

Fig. 46

where $\log C'_0$ is the intercept on the $\log C$ axis. If the $D_{\infty} - \log C$ curve is a straight line, as shown, C'_0 represents the concentration of bromide which is required to restrain development completely. That is, if the concentration of bromide present is C'_0 , this is just sufficient to prevent development

at the given exposure. The lower region of the curve is, however, much in doubt, as at very high concentration of bromide new reactions are indicated. Also, the photometric constant changes (the silver becomes very finely divided and of a brown or red color by transmitted light) because of the state of division and perhaps also the change of distribution of the silver particles. So far as observed, therefore, the curve appears to dip down, as shown by the dotted lines. Hence we are unable to determine, without many observations of this region, the value of the concentration of bromide which will prevent development. It is very probable that for different developers the values of C'_0 will stand in the same order and at about the same relative values as the concentrations required to stop development.

Whether or not this is true, it is possible to compare developers for the relative concentrations of bromide at which the same maximum density is produced. These will be in the same ratio as the anti-logs of the intercepts and probably in the same ratio as the concentrations required for complete restraint. The order of developers classified in this way for relative energy should be correct for compounds which do not shift the entire curve from its true position. According to relations pointed out in Chapter VI, some developers are able to reduce more silver than others of the same reduction potential because of physical or chemical factors other than their relative potentials. Possibly certain of these factors tend to decrease the amount of silver reduced. Consequently it is to

be expected that some developing agents will not be in their true positions in a classification made in this way, as is probably the case in the classification made by the previous method. However, the maximum densities are somewhat more accurately determined here, since several concentrations of bromide are used and therefore an average curve can be obtained, and some of the errors present in the second method are eliminated.

The method of comparison used is as follows: The average value of m found is 0.50 (Table 25). A straight line of slope $-m$ (see equation 35) was therefore put through the observed points in all cases, as in the usual treatment of such data. Thus a series of parallel $D_{\infty} - \log C$ curves for a number of developers on each plate is obtained, as typified by curves I and II in Fig. 46. For each emulsion a convenient standard value of D_{∞} is taken ($D_{\infty \text{ Std.}}$ in the figure), $\log C_1$ and $\log C_2$ are obtained, and from these, C_1 and C_2 , the concentrations of bromide required to bring the developers to the same equilibrium density. These are in the same ratio as $(C'_o)_1$ and $(C'_o)_2$. C_1 and C_2 are the relative resistances required to produce the same value for the total amount of work done (in reduction). Again, in analogy to mechanical measurements, the amount of work done is proportional to the force at work only if all other conditions are constant. This is not always true in photographic development, so that this method of classification is less reliable than that previously described.

Having obtained the values of the bromide concentrations which correspond to the standard maximum density, the developer for which the most consistent data were obtained was chosen as the standard for each emulsion. Assuming as before that the ratio of the resistances (bromide concentrations) measures the relative reduction potentials, values of the latter for comparison with previous results can be obtained

by multiplying the ratio $\frac{C_x}{C_{\text{Std.}}}$, that is, $\frac{C_1}{C_2}$, by the value of π_{Br} found for the standard developer by the first method. Or, the relative reduction potential may be numerically expressed as equal to $\frac{C_x}{C_{\text{Std.}}} (\pi_{\text{Br}})_{\text{Std.}}$

Table 25 gives the results obtained in this way. C is the concentration of bromide corresponding to the maximum density stated. The developers used as standards on each emulsion are indicated, with the values of π_{Br} as given in Chapter III.

TABLE 25

 Concentrations of Bromide Required to give the Same D_{∞} for Different Developers on the Same Emulsion

 All values for $m=0.50$

	For D_{∞} =3.0	Relative Reduction Potential	π_{Br} as found previously
	C	$\frac{C_x}{C_{Std.}}$	$(\pi_{Br})_{Std.}$
Seed 23 Emulsion of May, 1917			
M/25 Bromhydroquinone25	83	21
M/20 Monomethylparaminophenol18	60	20 —
M/20 Toluhydroquinone035	12*	2.2
M/20 Paraminophenol018 (Std. and =6)	6	6 —
M/20 Hydroquinone002	1.7	1 —
M/20 Chlorhydroquinone003	1*	7
M/20 Paraphenyglycine0016	0.5	1.6 —
Pure Bromide Emulsion, II			
	For D_{∞} =2.4		
	C		
M/25 Bromhydroquinone08 (Std. and =21)	21	21
M/20 Chlorhydroquinone013	3.4*	7
M/20 Paraphenyglycine028	5.9	1.6
Seed 23 Emulsion of June, 1919			
	For D_{∞} =3.4		
M/20 Paraphenyglycine06	3.7	1.6 —
M/20 Hydroquinone016	1.0	1.0 —
M/10 Ferrous Oxalate0014	.09	0.3
Seed 30 Emulsion of July, 1919			
	For D_{∞} =3.2		
M/20 Pyrogallol11 (Std. =16)	16	16
M/20 Paraphenyglycine002	0.9	1.6
M/20 Dimethylparaminophenol25	70*	10

An asterisk is used to designate those results which are inconsistent with the determinations by the first method. The numerical values throughout are of greater range, but most of the developers are placed in the same order as before. After obtaining these results it was felt that the method is of some value, yielding additional information on the development process.

The three methods used for estimating the reduction potential are then:

1. Measuring the density depression or lowering of the intersection point;

2. Classifying according to the equilibrium point; and velocity;

3. Comparing the concentrations of bromide at which the same amount of reduction is accomplished, or the concentrations required to restrain development completely.

Of these the first is most free from error. The phenomena described above, throw more light on the density-depression method, and are accordingly of more importance in that connection than in giving determinations of the reduction potential.

EFFECT OF BROMIDE ON γ_{∞}

The effect of bromide on the contrast has received considerable attention from time to time, but many of the published results and conclusions are erroneous. Some practical aspects of the subject are made clearer in the discussion of fog (Chapter VIII). Bromide in any normal developer may, as shown, cause a depression of density and cut down fog. Relations already indicated obtain, with the following practical result. The contrast obtainable in a given time may be lowered if sufficient bromide is present, but upon continued development the same contrast will be reached. The gamma for a fixed time of development is never increased by bromide except in so far as the increased contrast is due to the absence of fog. Practically, the printing contrast, γ_A of the negative may be higher than when no bromide is used, because of the absence of fog. Gamma and the effective contrast should not be confused.

γ_{∞} is not affected by bromide except in excessively high concentrations. That is, on ultimate development the theoretical contrast is independent of the bromide concentration. In practice the maximum effective contrast is usually (because of prevention of fog) increased by bromide to a certain extent. The relations for γ_{∞} as defined are more important theoretically, and for a given developer they aid in describing the character of an emulsion.

The method for the determination of γ_{∞} has been given in Chapter VI. Knowing the values of a , b , D_{∞} , and $\log E$, γ_{∞} is obtained from the equation

$$\gamma_{\infty} = \frac{D_{\infty} - b}{\log E - a} = \frac{D_{\infty} - b}{k}.$$

The effect for bromide on the separate factors is known. a is not changed by bromide. Hence the value $\log E - a$ is constant. D_{∞} decreases as a straight line function of the logarithm of the bromide concentration. b increases negatively in the same manner and at the same rate. Hence there should be no effect on γ_{∞} .

Making no assumptions for the time being, we may consider the data obtained for γ_{∞} .

The following tables show for the highest bromide concentrations, a slight lowering of γ_{∞} which is probably not real. At these high concentrations the photometric constant changes in that the density observed is too low in its indication of the mass of silver. Hence D_{∞} is also too low, and γ_{∞} accordingly falls off as the concentration increases. But it is doubtful that the actual mass of silver decreases faster than the normal rate even for as high bromide concentrations as those used here. A study of the photometric constant would be of value in this connection.

TABLE 26

$$\gamma_{\infty} = \frac{D_{\infty} - b}{\log E - A} \quad \left\{ \begin{array}{l} a \text{ and } b \text{ observed} \\ D_{\infty} \text{ computed from} \\ \text{observed } D-T \text{ curve} \end{array} \right.$$

<i>C</i> (mols per liter of potassium bromide)	M/20 dimethylparaminophenol on Special Emulsion IX	M/20 paraminophenol on Emulsion 3533
	γ_{∞}	γ_{∞}
0	1.48	1.84
.0025		1.75
.00354		1.80
.005		1.75
.0078		1.68
.01	1.45	1.65
.014		1.71
.02	1.45	1.71
.0283		1.70
.04	1.43	1.65
.057		1.53
.08	1.47	1.53
.114		1.59
.16	1.38	(1.37)
.32	1.31	Relation fails in this region
Mean	1.43	1.68

This slight downward trend may be due entirely to a change of grain size affecting the density readings at the higher concentrations, as noted above. In such a case all other measurements as recorded previously would be affected similarly, of course, but this does not change the relations. Within the limit of error (ten per cent) the value of γ_{∞} is constant.

Table 27 gives data for Seed 23 Emulsion of May, 1917, from material referred to in the foregoing.

TABLE 27

Seed 23 Emulsion of May, 1917.

C = Bromide Concentration (C) (mols per liter)	Values of $\gamma^\infty = \frac{D_\infty - b}{\log E - a}$										Average γ^∞
	0	.005	.01	.02	.04	.07	.08	.10	.16	.32	
Monomethylparaminophenol ..	2.46	2.31	2.48	2.51	1.97	2.26	2.20	2.75	2.38	2.33	2.33
Bromhydroquinone	2.54	2.45	2.48	2.51	1.86	1.86	2.13	2.06	2.29	2.29	2.29
Tolhydroquinone	1.74	1.82	1.82	1.82	1.98	1.98	1.79	(log E = 2.0)	1.75	1.75	1.75
	1.54	1.69	1.69	1.69	1.75	1.75	1.70	(log E = 2.1)	1.75	1.75	1.75
Paraminophenol	1.97	2.13	1.98	1.90	1.87	1.87	2.14	1.99	1.99	1.99	1.99
Chlorhydroquinone	1.68	1.49	1.54	1.74	1.53	1.53	1.62	1.71	1.62	1.62	1.62
Hydroquinone	1.48	1.50	1.62	1.53	1.64	1.64	1.52	1.55	1.55	1.55	1.55
Paraphenyglycine	1.43	1.65	1.72	1.39	1.39	1.39	1.52	1.55	1.55	1.55	1.55

In the experiments represented in Tables 26 and 27 fog is negligible where concentrations of bromide are above .005 to .01 M. The time required for a definite intermediate contrast increases rapidly as the higher concentrations are reached.

PROOF THAT THE DENSITY DEPRESSION MEASURES THE SHIFT OF THE EQUILIBRIUM,—*i. e.*, $d = (D_{\infty})_0 - (D_{\infty})_x$

As more data were secured and subjected to more careful analysis, the evidence became stronger that the lowering of the maximum density for a given concentration of bromide is the same as that of the density depression. This corresponds to the expression

$$d = (D_{\infty})_0 - (D_{\infty})_x,$$

where d is the density depression ($= -b$) and $(D_{\infty})_0$ and $(D_{\infty})_x$ are the maximum densities for the concentrations (of bromide) 0 and x respectively. Direct experimental verification of this relation is not possible because of the errors involved, as may be seen from an example. d for the concentration x was found to be $0.40 \pm .05$; $(D_{\infty})_0$ was $4.2 \pm .4$, and $(D_{\infty})_x$, $3.9 \pm .2$. The error in the latter case is less, as the value is taken from a curve through several observations, while the former, $(D_{\infty})_0$, is a single determination. The value of $(D_{\infty})_0 - (D_{\infty})_x$ is therefore indeterminate and between the limits 0.9 and -0.3 , which renders the proof that $d = (D_{\infty})_0 - (D_{\infty})_x$ impossible by this means. But other evidence is available.

In discussing the equation $\gamma_{\infty} = \frac{D_{\infty} - b}{\log E - a}$ it has been shown that γ_{∞} and a are constants independent of the bromide concentration, and that D_{∞} and b vary at the same rate with bromide concentration, since $-b = d$ and

$$d = m (\log C - \log C_0), \text{ or } b = -m (\log C - \log C_0)$$

$$\text{Also, } D_{\infty} = -m (\log C - \log C'_0).$$

That is, the rate of change of both b and D_{∞} with $\log C$ is $-m$. (Both diminish as C increases, b becoming larger negatively.) Consequently, as the bromide concentration is increased a definite amount, the change in b is the same as that in D_{∞} . From the equation

$$\gamma_{\infty} = \text{constant} = \frac{D_{\infty} - b}{\log E - a} = \frac{D_{\infty} - b}{\text{constant}},$$

it is evident that $(D_{\infty} - b)$ is a constant. Since both vary, the change in $-b$ is always equal to the diminution in D_{∞} .

The change of b from $C = 0$ to $C = X$ is the density depression and it is therefore equal to the shift of the density equilibrium point, or $(D_{\infty})_0 - (D_{\infty})_x$.

Table 24, giving slopes for both $d - \log C$ and $D_{\infty} - \log C$ curves, furnishes indirect evidence in this same direction. This evidence lies in the fact that both sets of data are derived from the same sources, and that while there are accidental errors in some of the individual determinations arising from plate curves out of place, there is quite marked parallelism between the values in the two columns. A variation in the rate of density depression is accompanied by a similar change in the maximum density curve. This is due to a real relation between the two, as there is no factor common to the two methods of computation.

As pointed out, there is no direct experimental verification of the fact that $d = (D_{\infty})_0 - (D_{\infty})_x$. Other cases examined showed more concordant results than expected. From the nature of the errors, the agreement is considered partly accidental.

TABLE 28

Comparison of Density Depression and Lowering of Equilibrium Density
Seed 23 Emulsion of May, 1917

	C^*	d	$(D_{\infty})_0 - (D_{\infty})_x$
M/20 Paraminophenol.....	.01	.20	.22
	.02	.12	.08
	.04	.26	.35
	.07	.38	.45
	.10	.57	.63
M/20 Chlorhydroquinone.....	.01	0	.05
	.02	.22	.17
	.04	.32	.32
	.08	.55	.36
	.16	.67	.60
M/20 Paraphenyglycine.....	.01	.65	.16
	.02	.70	.35
	.04	.92	.92
M/20 Hydroquinone.....	.005	.10	.02
	.01	.36	.04
	.02	.50	.33
	.04	.72	.55
	.08	1.12	.92
M/20 Monomethylparaminophenol.....	.01	.14	.50
	.02
	.04	.00	.60
	.08	.32	.90
	.16	.38	1.10
	.32	.50	.70
	.64	.48	1.00

* Mols of potassium bromide per liter.

(much too high)

However, the change of D_{∞} with bromide, the constancy of γ_{∞} and of a , and the relations for b are so well established that no more direct proof is needed. The equation:

$$d = (D_{\infty})_o - (D_{\infty})_x$$

is valuable as a step in the theory of the bromide depression method, since it shows that when the lowering of the intersection point of the H. and D. curves is measured as described in the first three chapters, in reality the change in the equilibrium is being measured; and this means that the method is capable of a satisfactory chemical interpretation. Further, the expression is useful in working out the more complete relations for the effect of bromide on the velocity curves, as is done below.

EFFECT OF BROMIDE ON K

The constant K in the velocity equation

$$D = D_{\infty} (1 - e^{-K \log t/t_0})$$

includes, (as it does in another form developed by Sheppard and Mees), the factors diffusivity, diffusion path surface of developable halide, and perhaps other unknown quantities. But K does not include the same set of factors here as it does in the other velocity equations, though the general nature of these quantities is as indicated. We should not expect a variation of bromide concentration to have any effect on K , since the individual components are not supposed to change. That K in the velocity equation used is practically constant was proved by considerable data. Two complete cases are given in Table 29.

TABLE 29
Constancy of K with Variable Bromide Concentration

Mols of potassium bromide per liter	M/20 dimethylp-aminophenol on Special Emulsion IX, Experiment		Mols of potassium bromide per liter	M/20 dimethylp-aminophenol on Special Emulsion IX, Experiment	
	hydrochloride on Emulsion 3533	106		hydrochloride on Emulsion 3533	106
C	K	K	C	K	K
.0	.30	.53	.0283	.48
.0025	.4204	.51	.63
.00354	.45057	.44
.005	.4408	.51	.56
.0078	.51114	.44
.01	.37	.44	.16	.47	.42
.014	.47228	.45
.02	.43	.42	.32	.45	.37
			.45	.44
			Mean	.44	.48

In Wilsey's equation, $D = D_{\infty} (1 - e^{-K(t-t_0)^b})$, K decreases and b increases with bromide concentration, as shown by computations from the paraminophenol data used in Table 30. As stated elsewhere, the maximum density calculated by this equation is often identical with that obtained from the form $D = D_{\infty} (1 - e^{-K \log t/t_0})$. Differences may occur for other types of curves, but none was found in the cases computed here. (For methods see Chapter V.) Table 30 gives the values of D_{∞} and K obtained by the two equations and of b in Wilsey's equation.

TABLE 30
Effect of Bromide on K

$D = D_{\infty} (1 - e^{-K \log t/t_0})$			$D = D_{\infty} (1 - e^{-K(t-t_0)^b})$		
C	D_{∞}	K	D_{∞}	K	b
0	4.20	.30	4.20	.23	.50
.0025	4.00	.42	4.00	.19	.59
.005	3.90	.44	3.90	.15	.60
.01	3.50	.37	3.50	.27	.50
.04	3.30	.51	3.20	.11	.81
.08	3.00	.51	3.00	.05	1.11
.32	2.20	.45	2.20	.03	1.03

VARIATION OF t_0 AND t_a WITH BROMIDE CONCENTRATION

t_0 in the velocity equation $D = D_{\infty} (1 - e^{-K \log t/t_0})$ is an empirical constant. When the $D - t$ curve is well fitted by the equation, t_0 indicates the length of the period of retardation. Its relation to the bromide concentration is taken up here principally because it is necessary as a constant in an equation to be used later.

t_0 is a straight-line function of the bromide concentration and the relation is

$$(t_0)_x = k C + (t_0)_0,$$

where $(t_0)_x$ is t_0 for the concentration x , C is the concentration x , and $(t_0)_0$ is t_0 for zero concentration of bromide. The straight-line relation is used for greater accuracy in the determination of $(t_0)_0$ below.

t_a , the time of appearance for a fixed exposure, has usually been measured visually, but this procedure involves too many indefinite factors. A better method is to read off from the $D - t$ curves the time of development required for a definite low density. A density of 0.2 used in this way yields more reliable information than visual measurements. The time of

development required to give a density of 0.2 at the standard exposure is a straight line function of C (the potassium bromide concentration) just as t_o is. Sheppard found t_a visual to be proportional to $\log C$. As a matter of fact, this is an approximation over a range up to .05 normal, but the complete relations for t_o and t_a have been investigated and the expression found to be of the form stated above:

$$(t_a)_x = k'C + (t_a)_o.$$

If the intercepts on the time axis are well determined for the $D - t$ curves, these values will be very close approximations to the true times of appearance. The values of these intercepts (t_o and t_a) can be found by fitting the equation

$$D = D_\infty (1 - e^{-K(t-t_o)})$$

to the first part of the curve only and thus evaluating t_o . When this was done t_o was proportional to C and not to $\log C$ as before.

EFFECTS OF SOLUBLE BROMIDES ON VELOCITY CURVES AS SEEN FROM MORE PRECISE DATA

Having investigated the general effects of bromide on the velocity curves and on the various factors appearing in the velocity equation, it is possible to examine more closely the effect on the curves themselves, and especially on other relations between the equilibrium values obtained with different concentrations of bromide. The possibility that the velocity curves might be considered as shifted downward, or depressed, by the action of bromide in the same way that the plate curve is, was suggested to the writer. It was thought that if a suitable mathematical analysis of the data was made, additional information would be secured concerning the chemical phenomena involved. Experimental proof of various hypotheses was necessary, however, and it was found that for this purpose complete data as well as great accuracy were necessary. It was extremely difficult to meet these requirements with some of the developers used, and consequently the experimental data were more limited than is to be desired. Again, however, there is abundant indirect proof of the assumptions made.

To increase the accuracy represented by the data, more plates were used for each bromide concentration, and development was carried out for longer times (up to thirty minutes).

All the quantities which are functions of the bromide concentration (D_∞ , t_o , b , etc.) were determined from smoothed

curves through the various observations. A relatively large number of concentrations was used. Quantities constant and independent of bromide concentration (K and a) were averaged from all the observations. In this way a table of values was secured which contains the least error for the conditions.

Table 31 contains complete data for M/20 paraminophenol. The observed values and those obtained from smoothed curves through the observations are placed side by side. The nature of the agreement is thus shown in detail.

TABLE 31
Average Data for Paraminophenol ¹

C	D_{∞}	D_{∞}	d	d	K	γ_{∞}	γ_{∞}	t_0	t_0	t_s	
Mols per liter of potassium bromide	Observed	From smoothed curve $m = 0.50$	Observed	From curve $m = 0.50$	Observed	Computed from Observations	Computed from data from curves	Computed from observations for each case	From smoothed curves	From smoothed curves	$\log_e t_0$
.0000	4.20	4.0030	1.84	1.80	(1.0)	1.9	.15	.64
.0025	4.00	3.94	.0	.0	.42	1.75	1.73	1.8	1.95	.15	.67
.0035 ⁴	4.00	3.86	.10	0	.45	1.80	1.69	2.0	2.069
.005	3.90	3.79	.09	.04	.44	1.75	1.68	1.85	2.05	.15	.73
.0078	3.60	3.71	.22	.12	.51	1.68	1.68	2.6	2.174
.01	3.50	3.63	.27	.19	.37	1.65	1.68	.88	2.1	.15	.74
.014	3.60	3.56	.30	.27	.47	1.71	1.68	2.0	2.279
.02	3.40	3.48	.32	.34	.43	1.71	1.67	1.85	2.2	.20	.79
.0283	3.40	3.41	.48	.41	.48	1.70	1.68	2.5	2.383
.04	3.30	3.33	.47	.49	.51	1.65	1.67	2.65	2.4	.25	.86
.057	3.20	3.26	(.30)	.57	.44	1.53	1.68	2.3	2.6	.50	.96
.08	3.00	3.19	.50	.64	.51	1.53	1.68	4.0	2.8	.85	1.03
.114	3.00	3.10	.62	.71	.44	1.59	1.67	3.6	3.2	1.4	1.16
.16	2.80 ²	3.02 ²	(.34) ³	.79	.47	1.37	1.67	4.0	3.7	2.1	1.31
.228	2.5045	4.5	3.1
.32	2.2045	5.5	4.5
.45	2.0044	6.5

Average Average Average
= .44 = 1.68 = 1.69

¹ Maximum fog at $C = 0$, and after 30 minutes' development, was 0.60.

² D_{∞} falls off (error in photometric constant, etc).

³ Straight-line relation fails at about $C = 0.16$.

A number of relations which have been pointed out are illustrated in this table. That D_{∞} decreases with $\log C$ at the rate $-m$ is shown by the agreement between the second and third columns. The constancy of K and of γ_{∞} are shown. We believe the results of the entire experiment, in which five hundred plates were used, to be as consistent and accurate as it is possible to secure under like conditions. The greatest

error lies in the determination of the constants and variables for $C = 0$ (no bromide), but this has been minimized by using the mean curves and extrapolating to zero.

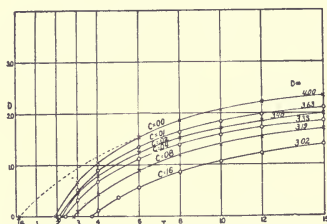

Fig. 47

The averaged data thus obtained are more accurate for any concentration of bromide than the observations at that concentration. By using these results the densities for the $D - t$ curves may be calculated, and these, with the exception of the initial period, where the velocity equation does not apply, give the result of observations on the velocity curves. Fig. 47 gives the $D - t$ curves for development up to fifteen minutes with several concentrations of bromide. These were computed from the equation $D = D_{\infty} (1 - e^{-K \log t/t_0})$ by using the averaged data from Table 31. These curves should not be considered merely computations, for beyond the initial period they represent the average results based on all the observations. Many observations were made for the range up to 30 minutes' development, and in nearly all cases the observations agree with the curves beyond the initial stage. The extent of the discrepancy between observations and computed curves at the beginning is indicated for the concentrations 0.0 and 0.16 M bromide. The exact nature of the agreement between the observations and the computed curves may be seen by comparing the values of D_{∞} , K , and t_0 as observed and as obtained from smoothed curves. These may therefore be considered as experimental observations of greater precision.

On examining the nature of these curves it is seen that they are parallel beyond the induction period. Hence, as previously indicated, the velocity is unchanged by bromide. Moreover it appears that the curves have been moved downward. That the lowering of the density at any time t (ignoring the beginning) is the same as the lowering of the maximum density, is demonstrated experimentally. That is, for D_0 and D_x (densities for concentrations 0 and x) at time t ,

$$D_0 - D_x = D_{\infty} - D_{\infty x}.$$

Additional data similar to those in Table 31 are given in Table 32 for M/20 dimethylparaminophenol on Special Emulsion IX.

TABLE 32¹

log $E = 3.0$
 $a = 0.28$

$m = .50$

	D_{∞}	D_{∞}	d^2	d		K	γ_{∞}	γ_{∞}	t_0	t_0	
	Observed	Computed from smoothed curve	Observed	From smoothed curve		Observed	Computed from observations	Computed from smoothed curves	Computed for each case	From smoothed curve	
C											$\log_0 t_0$
0	3.90	3.9053	1.48	1.43	.55	.48	-.73
.01	3.80	3.86	+ .14	.08		.44	1.45	1.45	.41	.49	-.71
.02	3.70	3.70	+ .24	.23		.42	1.45	1.45	.53	.51	-.67
.04	3.60	3.56	+ .31	.38		.63	1.43	1.45	.70	.56	-.58
.08	3.40	3.41	+ .54	.54		.56	1.47	1.45	.72	.64	-.45
.16	3.40	3.26	+ .41	.68		.42	1.38	1.45	.90	.80	-.22
.32	3.30	3.10	+ .33	.83	(Extrapolated)	.37	1.31	1.44	1.10	1.11	+ .11
.64	3.10	2.98	+ .3528	1.28	1.55	1.72	+ .54
						Average = .46	Average = 1.45				

¹ Maximum fog at C = 0, after twenty minutes development, = 0.82.

² d is low at high concentrations of bromide, due to secondary reaction.

The relations for the depression of the curves are well shown. The assumptions made, all of which are founded on the results of the experiments, and all of which have been discussed, are summarized below:—

With variable bromide concentration the following relations hold over a wide range:

1. a is constant and independent of bromide concentration;
2. b increases negatively with increase of bromide according to the equation.

$$b = -m (\log C - \log C_0);$$

3. d , the density depression, = $-b$, and therefore

$$d = m (\log C - \log C_0);$$

4. The course of the reaction with time of development is represented by the equation

$$D = D_{\infty} (1 - e^{-K \log t/t_0})$$

for all concentrations of bromide;

5. When the equation above is properly used, D_{∞} represents the equilibrium value for the density;

6. D_{∞} varies with bromide exactly as b does. Hence $d = D_{\infty 0} - D_{\infty x}$;
7. K is constant and independent of the concentration of bromide;
8. t_0 is a linear function of the concentration of bromide;
9. $D_0 - D_x = D_{\infty 0} - D_{\infty x}$ beyond the initial period.

THE DEPRESSION OF THE VELOCITY CURVES

The velocity equations for a given developer with concentrations of bromide 0 and x ($C = 0$ and $C = x$) for a common time of development, t , are:

$$\text{for } C = 0 \quad D_0 = D_{\infty 0} (1 - e^{-K \log t/t_0}) \quad (\text{unbromided}) \quad (36)$$

$$D_x = D_{\infty x} (1 - e^{-K \log t/t_0x}) \quad (\text{bromided}) \quad (37)$$

and the depression is the difference between the two at the time t . Such a value of t must be chosen that only the region where the velocity is not affected by bromide (i. e., beyond the period of induction), is considered. It is convenient to express equation 37 somewhat differently. The general form of the velocity equation is

$$D = D_{\infty} (1 - e^{-K \log t/t_0}), \quad (38)$$

which may be written

$$K (\log t - \log t_0) = \log \frac{D_{\infty}}{D_{\infty} - D}. \quad (39)$$

$\log \frac{D_{\infty}}{D_{\infty} - D}$ plotted against $\log t$ is a straight-line of slope K

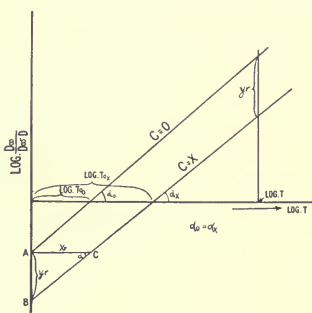

Fig. 48

and intercept $\log t_0$ on the $\log t$ axis. It has been shown that K is constant for variable bromide concentration. Hence, two velocity curves of the same form as (39) for $C = 0$ and $C = x$ have the same slope K , and may be drawn as parallel straight lines. Referring to Fig. 48, then, K is the same for both cases—that is, $\alpha_0 = \alpha_x$. In the triangle ABC , AC is the difference between the intercepts. Calling AC , X_r and AB , Y_r ,

$$X_r = \log t_{0x} - \log t_0 = \log \frac{t_0x}{t_0}$$

$$\text{and } Y_r = KX_r = K \log \frac{t_o^x}{t_o^o} . \quad (40)$$

The equation for the bromided curve ($C = x$) is

$$\log \frac{D_{\infty}^x}{D_{\infty}^x - D_x^x} = K \log t - K \log t_o^x , \quad (41)$$

But from the equation 40

$$K \log t_o^x = Y_r + K \log t_o^o . \quad (42)$$

Making this substitution in (41) and converting to the exponential, we may write the equation for the curve $C = x$ in the form

$$D_x = D_{\infty}^x (1 - e^{-K \log t/t_o^o + Y_r}) . \text{ (bromided) } \quad (43)$$

on now subtracting (43) from (36) we get the depression

$$D_o - D_x = D_{\infty}^o (1 - e^{-K \log t/t_o^o}) - D_{\infty}^x (1 - e^{-K \log t/t_o^o + Y_r}) \quad (44)$$

which by algebraic treatment and use of the assumption, based on experimental evidence, that $D_o - D_x = D_{\infty}^o - D_{\infty}^x$ reduces to the expression

$$D_o - D_x = D_{\infty}^x (e^{Y_r} - 1) . \quad (45)$$

Also, $D_{\infty}^o - D_{\infty}^x = D_{\infty}^x (e^{Y_r} - 1)$

from which $D_{\infty}^x e^{Y_r} = D_{\infty}^o$. (46)

Substituting the value of Y_r gives for the depression, from equation 45:

$$d = D_{\infty}^o - D_{\infty}^x = D_o - D_x = D_{\infty}^x (e^{K \log \frac{t_o^x}{t_o^o}} - 1) \quad (47)$$

and the relation

$$D_{\infty}^x e^{K \log \frac{t_o^x}{t_o^o}} = D_{\infty}^o .$$

First let us test equations 47 and 48 by using them on the results given in Tables 31 and 32. Table 33 gives the results for paraminophenol (See Table 31). All logarithms are to the base e .

TABLE 33

Depression of Velocity Curves by Bromide. M/20 paraminophenol on Emulsion 3533

C	$\log_e t_{ox}$	D_x	e^{yT}	$D_{\infty x} e^{yT}$	$D_{\infty x}(e^{yT}-1)$	d from Table 31	$D_o - D_x$ from Fig. 47	$D_{\infty o} - D_{\infty x}$
.0025	.67	3.94	1.01	3.98	.04	006
.00354	.69	3.86	1.022	3.94	.08	014
.005	.73	3.79	1.041	3.95	.16	.0421
.0078	.74	3.71	1.045	3.88	.17	.1229
.01	.75	3.63	1.046	3.80	.18	.19	.24	.37
.02	.79	3.48	1.068	3.72	.24	.34	.36	.52
.04	.86	3.33	1.102	3.67	.33	.49	.50	.67
.057	.96	3.26	3.75	.49	.5774
.08	1.03	3.19	1.188	3.79	.60	.64	.67	.81
.114	1.16	3.10	3.90	.79	.7190
.16	1.31	3.02	1.342	4.05	1.03	.79	.96	1.02

Column No.

1 2¹ 3¹ 4 5 6² 7³ 8 9

$D_{\infty o} = 4.00$
 $\log t_o = 0.64$
 $K = .44$

¹ These values are taken from Table 31.

² Computed depression.

³ Depression from mean curve through observations.

If equations 47 and 48 hold when applied to the data, the values in column 5 will always equal 4.00 (see equation 48) and the values in columns 6, 7, 8, and 9 will be in agreement (equation 47). The relations derived are very closely approximated. In column 5 there is a slight drop in the values for the intermediate concentrations. ($D_{\infty o} - D_{\infty x}$) in column 9 is a little high, apparently because $D_{\infty o}$ is too high (i. e., the value 4.00 as determined from the average of the observations at other concentrations should be about 3.90). Column 5 also indicates that $D_{\infty o}$ is somewhat high. But the agreement is fairly satisfactory considering the nature of photographic data of this kind.

Table 34 gives similar computations for M/20 dimethylparaminophenol based on data given in Table 32.

TABLE 34

Depression of Velocity Curves by Bromide. M/20 dimethylparaminophenol on Special Emulsion IX

$\log t_{O_0} = -0.73$
 $K_{O_0} = 0.46$

C	$\log_e t_{ox}$	e^{yT}	$D_{\infty x}$	$\frac{D_{\infty o}}{D_{\infty x} e^{yT}}$	$D_{\infty o} - D_{\infty x}$	$d = \frac{d}{D_{\infty x}(e^{yT}-1)}$	d from observation (smoothed) curve
.01	-.71	1.009	3.86	3.90	.04	.04	.08
.02	-.67	1.028	3.70	3.80	.10	.13	.23
.04	-.58	1.071	3.56	3.82	.34	.25	.38
.08	-.45	1.138	3.41	3.88	.49	.47	.54
.16	-.22	1.264	3.26	4.13	.64	.86	.68
.32	+.11	1.471	3.10	4.55	Does not hold. t_o for these cases is too high.		
.64	+.54	1.794	2.98	5.33			

$D_{\infty o} = 3.90$

The agreement is satisfactory, but it is seen that in both cases the relations fail at concentrations of bromide greater than 0.16 M. Indeed, as indicated elsewhere, the fact that the various "laws" seem to break down in this region may be because of our inability to determine the mass of silver by the measurement of density, as at about $C = 0.16$ M. in both cases the deposits begin to appear brownish by transmitted light. However, from other data it is suspected that a reaction occurs between the bromide and the silver halide at very high concentrations, or that the bromide exerts some physical influence.

By combining certain of the equations derived here with others previously established new relations may be shown, most of which, however, have little practical application.

The general conclusions relative to this subject may be summarized as follows:

A comparison of the bromide concentrations at which two developers can produce the same maximum density gives a comparison of the concentrations theoretically required to prevent development at the given exposure. In general this gives a measure of the relative reduction potentials of the two developers, but it will not serve for those cases in which factors other than the reduction potential control the character of development.

The maximum contrast, γ_{∞} , is unchanged by bromide.

The depression of density, or lowering of the intersection point, d , has been shown to be equal to the shift of the equilibrium, or

$$d = D_{\infty 0} - D_{\infty x}.$$

The velocity constant K is not affected by bromide.

t_0 and t_a , the retardation time and time of appearance respectively, are linear functions of the bromide concentration.

The only effect of bromide on the velocity of development is a change during the period of induction. After this stage the velocity is independent of the bromide concentration.

The effect of bromide on the velocity curves consists in a downward displacement beyond the initial period. This displacement is equal to the normal density depression d , as indicated by equation 47 above.

CHAPTER VIII

The Fogging Power of Developers and the Distribution of Fog over the Image

THE NATURE OF FOG

Though important from theoretical and practical stand-points, the subject of so-called chemical fog has received relatively little attention from photographic investigators. Some more or less incomplete microscopic studies have been published, but they are not of importance in the present discussion. Theoretically it should be possible to secure from the study of fog much information on the mechanism of the selective reduction of the latent image, the fact on which the entire practical application of photography rests. Present knowledge of the properties of developing agents does not offer any conclusive evidence as to which of these properties is the factor controlling this selective action.

No attempt has been made in the present instance to investigate the subject generally, but material gathered in connection with work already described furnishes much information on fog, and additional experiments have been carried out where necessary. Several series of experiments performed with different developers on the same emulsion gave data on the relative fogging powers of developers, and miscellaneous results throw light on several much-discussed questions.

The term fog as used here refers to the deposit resulting from the development of "unexposed" silver halide. Inasmuch as it is impossible to prepare emulsions which do not contain some grains affected by light, however small the proportion of such grains may be, some of them may be finally reduced, thus contributing to the result known as chemical fog. Furthermore, it has been shown that certain compounds have the power of rendering silver bromide developable, turpentine being a notable example. Without considering the nature of this action, we shall refer to substances of this kind as having the power of nucleation—that is, of forming nuclei in the presence of which reduction and deposition of silver may ensue. Aside from such phenomena, radio-active substances are present everywhere to some extent, and they no doubt contribute developable grains to the aggregate. Hence an emulsion always contains reducible nuclei. The deposit

resulting from the developable grains in an "unexposed" emulsion (due to light, radio-activity, and chemical nucleation) is termed emulsion fog.

It is not known how large a proportion of the total reduction of presumably unexposed silver bromide is due to emulsion fog. Though this percentage is probably relatively small, there is at present no verification of this. Although nucleation may be effected in different ways, the resultant grains probably do not differ. From what has been said it is evident that the nature of the developer has a considerable effect on the degree to which the development of these unexposed grains takes place, and its influence on this may differ from its effect on the development of the image because of the greater dispersity and different arrangement of the fog grains. Considering this, it is not necessary to account for all of the fog by assuming that new grains are rendered developable, since it is possible that most of the grains forming the fog image possess nuclei and are developable before the developer is applied, the difference in the developing properties of different reducers accounting for the variation in the fog density obtained. However, if this were true, and no other grains were developed, we should probably find the fogging power of developers standing in the same order as certain of their chemical characteristics, especially their reduction potentials. This has not been found to be the case. Therefore the conclusion is that in addition to grains rendered developable by the action of light on the emulsion and those in the emulsion which are developable from whatever cause, there is development of new grains which are not capable of reduction except by some specific action of the reducing solution. This is termed chemical fog, and is believed to predominate.

Chemical fog may be produced in several ways and may vary in physical and chemical structure. Like the image, it may result from either chemical or physical development. If from chemical, the reducing agent or its salts are supposed to have the power of nucleation, in which case the grain is developed *in situ*. The fog may differ from the image grain in rate of development, in internal structure, and in arrangement. Oxidation products of the developer may form a complex with the spongy silver in either case, whether development is chemical or physical. Fog developed physically results from solution of the silver bromide reduction, and deposition from the solution on nuclei in the emulsion. In this case the structure of the fog image is usually decidedly different from that of the developed image, and the fog lies

partly on the surface of the latter. It is often so fine-grained that it has selective scattering power for light, in which case it is differently colored in reflected and in transmitted light. The terms pleochroic and dichroic are applied to this kind of fog. Dichroic fog is common and often troublesome.

We cannot distinguish, except in a very general and qualitative way, between fog due to these various chemical causes, nor between chemical fog and emulsion fog, for that matter. Consequently we must deal with the entire resultant effect. It would not be surprising to find (as was found) that the relations for fog are somewhat different from those for the image.

Mees and Piper believed fog to be chiefly a matter of reduction potential. The latent image being at a higher oxidation potential than unexposed silver bromide, the selective reduction of the latter results from proper adjustment of the reduction potential of the developer. A developer of too high potential reduces the unexposed silver bromide. Also, the reduction potential necessary for development of either exposed or unexposed halide is lowered by increased solubility of the silver salt in the developer. Accordingly, solvents of silver bromide are powerful fogging agents. This is illustrated by thiocarbamide which, Mees and Piper state, so increases the solubility of the silver bromide that a developer to which it is added reduces the whole of the silver halide. Time is required, however, for the thiocarbamide to lower the resistance sufficiently, so that normal development begins first. The bromide in the gelatine emulsion then raises the resistance (locally) and prevents the action of the thiocarbamide. The extent to which the fog is prevented is proportional to the amount of bromide locally liberated.

Now, although the action of thiocarbamide is accurately described by Mees and Piper, there is one fact which is not explained by the assumptions made. It appears that the developer can reduce no more silver with the thiocarbamide than without it. The action of each substance seems to proceed independently, except that, as stated, the by-product of one interferes more and more with the other. But the thiocarbamide does not make it possible for the developer to reduce any more or different grains than it could alone. This experiments recently carried out tend to show.

Consequently the explanation previously given must be modified by assuming the thiocarbamide capable of nucleation, rather than able, because of higher reduction potential, to reduce silver grains which the developer can not. Further-

more no connection can be shown between fogging power and reduction potential, it being a notable fact that many developers (in the purest possible state) of remarkably low reduction potential can produce excessive fog in the absence of alkali. It therefore seems more logical not to begin with the assumption that fogging propensity is governed by reduction potential.

There is little doubt, however, that increased solubility of silver bromide is associated with greater fog density. The production of nuclei, or the chemical action resulting in this, is doubtless increased by higher solubility—i. e., greater concentration—in the same manner that other chemical reactions are.

FOGGING POWER

The term fogging power has been used rather freely thus far, though no precise definition of it has been given. Mees and Piper defined it as

$$\phi = \frac{F}{K},$$

where F is the "rate at which the developer reduces unexposed silver bromide, and K is the rate at which the image is reduced." F is not actually the fogging rate, but these investigators found that fog plotted against time of development gave a straight line through the same origin for different cases, from which they concluded the fogging rate to be proportional to the density at any time. Accordingly they used observed densities (for fog) at ten minutes' development. In certain cases this did not prove satisfactory.

K is the constant used in the equation $D = D_{\infty} (1 - e^{-Kt})$.

The writer finds from extensive experiments that the above relation for F is inaccurate. As shown below, the fog-time curve is not a straight line, and for different developers the origin may vary greatly. Also, the velocity equation $D = D_{\infty} (1 - e^{-Kt})$ is not sufficiently well followed by the development of the image. (See Chapter V.) The definition of fogging power should therefore be revised.

It has been shown that the normal development process (for the image) is described fairly accurately by the equation

$$D = D_{\infty} (1 - e^{-K \log t/t_0}). \quad (28)$$

Experimental data show that the fog-time function is also an exponential. Accordingly it was attempted to fit the expression above to the fog curve, but without success. However,

it was found that the fogging action could be expressed by the first-order reaction law with a correction for the period of delay. This equation, discussed in Chapter V, has the form

$$D = D_{\infty}(1 - e^{-K(t-t_0)}). \quad (26)$$

The fogging velocity is therefore given by

$$\frac{dD}{dt} = K(D_{\infty} - D).$$

Equation (26) was applied to many experiments and found to fit the data closely. Observations of fog were made on all plates developed for the previous work, the readings for the fog density being made on the half of the plate which had not been exposed.

Fig. 49 illustrates the kind of data secured. The upper curve is for the image. The computed points (black dots) were obtained from the equation

$$D = D_{\infty}(1 - e^{-K \log t/t_0}).$$

The lower curve is for the fog. The computed points (black dots) were derived from

$$D = D_{\infty}(1 - e^{-K(t-t_0)}).$$

The developer was M/20 hydroquinone (with 50 grams sodium sulphite and 50 grams sodium carbonate per liter) used on Seed 30 emulsion with no bromide. Many developers used in the same way indicated

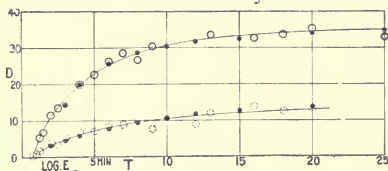

Fig. 49

as velocity equations are concerned.

Thus there is evidence that development of the image and of fog do not follow the same law, and that the velocity functions are different.

$$\text{Velocity of development } \frac{dD}{dt} = \frac{K}{t} (D_{\infty} - D) \text{ Image}$$

$$\text{Fogging velocity } \frac{dD}{dt} = K(D_{\infty} - D) \text{ Fog.}$$

This is to be explained by the theories outlined above. If chemical fog predominates, as is supposed, and especially if this results largely from physical development (as is also likely), the development of fog grains is probably less restricted than development of the image, where the grains are fixed in place and have a definite distribution. In other words, the

production of fog would be more likely to follow the ordinary laws for a chemical reaction not subject to interference, namely, the first-order reaction law. The development of fog is then freed from one of the most complicating factors, the presence of gelatine.

It is now obvious that fogging proceeds to a definite limit, or equilibrium value, just as the image does; but some of the relations for equilibrium values previously applied do not hold for fog.

Table 35 gives data on the development of fog and of the image for numerous reducing agents on Seed 30 emulsion. The reducers in the first section of the table are arranged in order of reduction potential (see column 10). Values in the second section are reasonable determinations from velocity and other data. Columns 2, 3, and 4 give values of D_{∞} , K , and t_0 for the fog, computed from equation 26 above. Column 5 shows the fog observed after 10 minutes' development, column 6 after 20 minutes'. Columns 7, 8, and 9 are the image characteristics computed from equation 28 for comparison. Column 11 shows the amount of fog remaining to be developed after 10 minutes and column 12 the fogging velocity after 10 minutes' development. It is evident that none of the characteristics of fog vary with the reduction potential of the developer.

It is inconsistent to seek a definition of fogging power analogous to that of Mees and Piper. K for the image (applying the new velocity equation) is not the rate of development except for a particular set of conditions which are practically unattainable. The velocity of development for the image is

$$\frac{dD}{dt} = \frac{K}{t} (D_{\infty} - D).$$

Hence K is the velocity only when $t = 1$ and at the same time $D_{\infty} - D = 1$. And it is now seen that F , the fog at time t , is not simply proportional to the fogging rate.

Developers were then classified according to values of D_{∞} for the fog image, or the maximum or equilibrium value for the fog, as given in Table 36. Here the values of $F_{20'}$ and the fogging velocity are roughly in the same order. (The order is correct for developers of equal K_{Fog} values and constant t_0 .) Accordingly it may be said that the fogging powers of two developers are to each other as the values of the maximum fog. This, though only an approximation, is a practical

TABLE 35
Fog and Image Data

1	Experiment No.	2		3		4		5		6		7		8		9		10	11	12
		D_{∞}	K	t_0	F_{10}'	F_{20}'	D_{∞}	K	t_0	D_{∞}	K	t_0	π	Fog $D_{\infty} - D$ after ten min. after ten min.	$K (D_{\infty} - D)$ Fogging velocity after ten min.					
	M/10 ferrous oxalate.....	.43	.10	..	.28	.38	3.10	.55	3.10	.55	.97	30	.15	.015						
	Paraphenylenediamine (no alkali)	fog negligible					1.70	.34	1.70	.34	2.10	.30	..	.053						
	Hydroquinone.....	1.30	.12	0	1.08	1.32	3.80	.95	3.80	.95	1.80	1.00	.42	.053						
	Toluhydroquinone.....	2.45	.19	0	2.10	2.34	4.40	.63	4.40	.63	1.35	2.20	.35	.066*						
	Paraminophenol.....	.70	.11	3.15	.22	.44	4.20	.44	4.20	.44	1.00	6	.48	.053						
	Chlorhydroquinone.....	.60	.16	0	.45	.55	4.00	.52	4.00	.52	1.30	7	.15	.024						
	Paramino-ortho-cresol.....	.65	.09	0	.40	.57	3.80	.70	3.80	.70	.87	7	.25	.022						
	Dimethylparaminophenol.....	.99	.08	0	.48	.70	3.20	.61	3.20	.61	.75	10	.51	.041						
	Pyrogallol.....	1.30	.05	0	.60	.88	4.00	.57	4.00	.57	.70	16	.70	.035						
	Monomethylparaminophenol.....	1.30	.11	0	.55	.90	3.60	.58	3.60	.58	.70	20	.75	.088						
	M/25 bromhydroquinone.....	.60	.07	0	.30	.55	3.80	.66	3.80	.66	1.27	21	.30	.021						
	Methylparamino-ortho-cresol.....	1.20	.10	0	.86	1.03	4.00	.60	4.00	.60	1.33	23	.44	.044						
	Diaminophenol (no alkali).....	.70	.14	0	.46	.62	3.60	.55	3.60	.55	.36	30-40	.24	.034						
	Dichlorhydroquinone.....	.75	.06	0	.34	.49	3.60	.53	3.60	.53	.80	(11)	.41	.025						
	Dibromhydroquinone.....	1.00	.07	0	.54	.76	3.80	.80	3.80	.80	.80	(8)	.46	.032						
	Phenyldiazine (no alkali).....	.65	.05	12	.04	.18	3.80	.03	3.80	.03	8.50	1	.61	.031						
	Paramino-meta-cresol.....	2.60	.16	0	2.08	2.51	4.00	.72	4.00	.72	1.24	(9.5)	.52	.083						
	Diaminophenol + alkali.....	1.30	.11	0	.93	1.20	4.20	.60	4.20	.60	.60	(40+)	.37	.041						
	Pyrocatechin.....	.40	.15	0	.28	.38	3.60	.52	3.60	.52	.6012	.018						
	Duratol.....	.30	.11	0	2.40	.34	2.40	.34	2.27011						
	Edinol.....	.30	.11	0	.27	3.60	.46	3.60	.46	1.9010	.011						

* Later work on the Toluhydroquinone used for this investigation makes it probable that its high fogging action was due to chemical impurities. All developing agents are very difficult to obtain of high purity and numerical values for fog are therefore open to criticism.—Editor.

fog picture $D = D_{\infty} (1 - e^{-k \ln(t/t_0)})$

classification as it indicates roughly the relative amounts of fog produced at a given time. But a fogging agent with higher K or greater t_0 will be out of place on this scale.

In Table 37 the developers are arranged in order of fogging velocity after 10 minutes. This seems on the whole the best classification, as the fog for a definite time is given in approximately the right order and other properties are in a more consistent order, though no definite rules may be established.

The three experiments marked with an asterisk are obviously out of order. In the case of paraminophenol and phenylhydrazine this is due to the high value of t_0 , the time at which fogging begins.

Thus it is obviously impossible to attach much significance to reduction potential so far as fogging tendencies are concerned. Two other possibilities present themselves. Either the fog is due to substances other than the developer, or the developers must be assumed to have the power of nucleation or the ability in some way to develop the unexposed grains, and in a manner not related to the reduction potential, but depending rather on other chemical properties. The first of these assumptions is untenable unless the second is true. It can be shown that small quantities of foreign substances produce great changes in the fogging power. But the effect of bromide on fog is such as to make it quite certain that these foreign substances are of low reduction potential. This may be due to their low concentration, but the maximum fog values should be influenced in the same way. And we are again confronted by the evidence that fog cannot be accounted for by reduction potential. A number of the developing agents in the above list were very pure, so that any foreign substances present must have been in exceedingly low concentration.

If we accept the explanation that the developers have other (and comparatively unknown) specific properties which control their solvent action on silver bromide and their power to reduce silver from it without the aid of large numbers of nuclei affected by light, the results may later be shown to be in accord. This opens up new questions which cannot be answered from present information.

THE DISTRIBUTION OF FOG OVER THE IMAGE

From the time of Hurter and Driffeld's first investigations numerous workers have assumed that fog is evenly distributed over the image, and have accordingly subtracted the fog readings from density values for sensitometric strips. More

TABLE 36
Classification of Developers According to Maximum Fog

	(D_{∞}) Fog	(D_{∞}) Image	π Br	(K) Fog	(K) Image	F after 20 minutes	Fogging Velocity after 10 minutes
Paramino-metacresol.....	2.60	4.00	(9.5)	.16	.72	2.51	.083
Tolhydroquinone.....	*2.45	4.40	2.2	.19	.63	2.34	.066
- Hydroquinone.....	1.50	3.80	1.0	.12	.95	1.32	.053
- Diaminophenol + alkali.....	1.30	4.2	(40+)	.11	.60	1.20	.041
- Monomethylparaminophenol.....	1.30	3.60	20	.11	.58	.90	.088
Pyrogallol.....	1.30	4.00	16	.05	.57	.88	.035
Methyl paramino-orthocresol.....	1.20	4.00	23	.10	.60	1.03	.044
- Dibromhydroquinone.....	1.00	3.80	(8)	.07	.80	.76	.032
- Dimethylparaminophenol.....	.99	3.20	10	.08	.61	.70	.041
- Dichlorhydroquinone.....	.75	3.60	(11)	.06	.53	.49	.025
- Diaminophenol, no alkali.....	.70	3.60	(30)	.14	.55	.62	.034
- Paraminophenol.....	.70	4.20	6	.11	.44	.44	(.053)
- Paramino-orthocresol.....	.65	3.80	7	.09	.70	.57	.022
- Phenylhydrazine, no alkali.....	.65	3.50	1.0	.05	.03	.18	.031
- Chlorhydroquinone.....	.60	4.00	7	.16	.52	.55	.024
- Bromhydroquinone.....	.60	3.80	21	.07	.66	.55	.021
- Ferrous oxalate.....	.43	3.10	0.3	.10	.55	.38	.015
- Pyrocatechin.....	.40	3.6015	.52	.38	.018
- Edinol.....	.30	3.6011	.46	.27	.011
- Duratol.....	fog negligible	2.4034	.05
- Paraphenylene diamine, no alkali	fog negligible	1.70	0.434	.05

*See note on p. 140

TABLE 37
Classification of Developers According to Fogging Velocity

	Fogging velocity after 10 minutes	Fogging velocity after 2 minutes	π Br
- Monomethylparaminophenol.....	.088	.90*	20
Paramino-metacresol.....	.083	2.51	(9.5)
Tolhydroquinone.....	.066	2.34	2.2
- Hydroquinone.....	.053	1.32	1
- Paraminophenol.....	.053	.44*	6
- Methylparamino-orthocresol.....	.044	1.03	23
- Diaminophenol.....	.041	1.20	(40)
- Dimethylparaminophenol.....	.041	.70	10
Pyrogallol.....	.035	.88	16
- Diaminophenol, no alkali.....	.034	.62	(30)
- Dibromhydroquinone.....	.032	.76	(8)
- Phenylhydrazine, no alkali.....	.031	.18*	less than 1
- Dichlorhydroquinone.....	.025	.49	(11)
- Chlorhydroquinone.....	.024	.55	7
- Paramino-orthocresol.....	.022	.57	7
- Bromhydroquinone.....	.021	.55	21
- Pyrocatechin.....	.018	.38
- Ferrous oxalate.....	.015	.38	0.3
- Edinol.....	.011	.27

recently several investigators have questioned this procedure, and one or two have suggested what may now be proved, that fog (over the image) decreases as the image density increases. From the beginning of the present investigation the total density was read, and the fog determined separately. The total densities only were used in studying the results, and it was assumed that the higher densities were free from fog. In certain cases this led to results somewhat different from those obtained by other workers, but the former are so much more consistent throughout that they are considered excellent indirect evidence on the question of fog distribution.

Some features of this indirect proof are given below. The results always indicate that there is much less fog over the high densities than over the low densities.

Fig. 39 is an exaggerated example of how the contrast, γ , decreases with time beyond a maximum, a fact which can be explained reasonably only by the growth of more fog over the low densities.

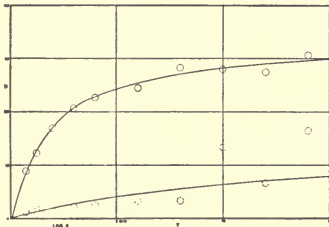

D-t curves for image (top) and for fog.
Fig. 50

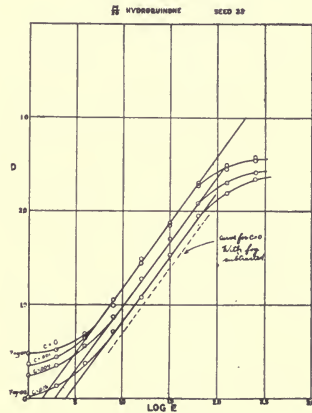

Fig. 51

Fig. 50 gives other evidence that the high densities are relatively free from fog. The curve is density plotted against time, both for the image and for the fog. The developer was M/20 monomethylparaminophenol. Plates were developed for ten and fourteen minutes in the presence of impurities causing excessive fog. The great increase in chemical fog may be seen from the fog curve at the times mentioned. At the same time the image densities at $\log E = 2.4$ for the same

plate lie on the normal density-time curve for the image. These are unaffected by the fog.

Fig. 51 represents development of a Seed 23 emulsion with M/20 hydroquinone at bromide concentrations 0, .001, .004, and .016 M. The plates are developed to equal gammas. The fog for the upper curve is 0.48 and for the lower 0.02. Examination of the curves shows that the bromide cuts down the fog to a greater extent than it does the image, though this could be shown much better by plates more badly fogged. The lowering of the curves is due to the normal depression by bromide, previously described.

The procedure of subtracting the fog from all densities can be shown to be erroneous. If the fog is subtracted from the upper curve and the curve for $C = .016$ M., the resultant curve for no bromide will lie below that for $C = 0.016$ M.—a result which would indicate that the developer produces greater image density with bromide than without it. In this particular instance it is probable that there is practically no fog over the image in the region of correct exposure (the straight line region). Such cases occur frequently.

The relation of fog density to bromide concentration has not been thoroughly investigated owing to the low fog densities when any appreciable concentration of bromide is used. In general, it is found that the addition of a very small amount of bromide greatly reduces the fog—that is, the absolute depression of fog is greater than that of the image. Experiments of a preliminary nature and indirect evidence indicate that fog density may be a function of bromide concentration somewhat different from image density. Whether or not this is true we are not prepared to state.

With reasonable evidence that high densities are free from fog, and the well founded assumption that the laws for the growth of the image, as previously described, are at least nearly correct, more definite ideas of the distribution of fog over the image may be expressed. Experimental data for a developer giving very bad fog (impure monomethylparaminophenol) are given in Fig. 52. The observed points are for five and ten minutes' development. From complete data for the developer the intersection of the H. and D. straight lines was found to be at $\log E = .32$ and on the $\log E$ axis.

The straight lines for the image were drawn from the density-time curve for $\log E = 1.8$. Having subtracted the fog from the total density for the lowest exposure ($\log E = 0$), and having made observations with enough bromide to eliminate most of the fog, it is possible to draw fairly correctly

the toe of the curve for the image. Although this is not absolutely correct, the relations are probably very closely approximated. Other evidence strengthens this belief.

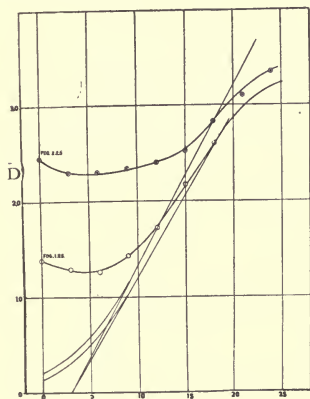

Log E
Fig. 52

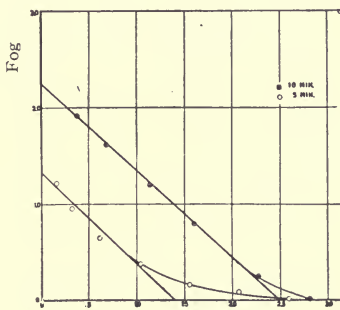

Image Density
Fig. 53

TABLE 38

Fog Distribution
(Impure Monomethylparaminophenol on Seed 23 Emulsion)

After 10 minutes

Log E =	0	.3	.6	.9	1.2	1.5	1.8	2.1	2.4
Total D	2.45	2.30	2.30	2.34	2.40	2.52	2.82	3.10	3.36
Image	.20	.38	.68	1.14	1.60	2.27	2.82	3.10	3.36
Fog	2.25	1.92	1.62	1.20	.80	.25	0	0	0

After 5 minutes

Total D	1.38	1.28	1.26	1.42	1.72	2.16	2.60		
Image	.16	.32	.61	1.04	1.55	2.07	2.59		
Fog	1.22	.96	.65	.38	.17	.09	.01		

On subtracting the image density as read off from the image curve which is free from fog, the value of the fog may be obtained for a given image density. (See Table 38). Plotting the value of fog thus obtained against the image density for both five and ten minutes' development gives the two curves of Fig. 53, which are approximately straight lines over a range of image densities. These curves indicate that the fog varies with the image density as follows:

$$F = k (D_i - D_{i_0}).$$

Here k is the slope of the straight line and is negative. F is the fog for the image density D_i , and D_{i_0} is the intercept on the horizontal axis, or the density over which there is no fog. As seen from the figures, the statement that D_{i_0} is the minimum density over which there is no fog is not exact because of departure from the straight-line relation at higher densities.

Assuming for the time being that these conclusions are correct, a relation between fog and bromide concentration may be formulated. Each image density represents the formation of a certain amount of soluble bromide in the emulsion, and the concentration of the bromide may be roughly estimated as follows: No matter what the exact chemical mechanism of development may be, one ion of bromine is formed for each ion of silver reduced, and the bromine will be present combined with sodium (if the alkali is sodium carbonate). One gram atom of silver (108 gms.) therefore corresponds to one gram molecule (103 gms.) of sodium bromide, and the two are produced in equal amounts. Density is proportional to silver by the photometric constant, P .

P is defined as $\frac{\text{gm. Ag}}{100 \text{ cm.}^2}$ when $D = 1.00$. P has been found to be 0.0103.¹ For a density of 1.00 therefore about 0.01 gm. of sodium bromide is produced in an area of 100 sq. cm. of the emulsion. The emulsion when swollen has a thickness of about 0.2 mm. (0.02 cm.). The volume of 100 sq. cm. is therefore 2 cc., and the maximum concentration of sodium bromide would be $\frac{0.01}{2} = .005$ gm. per cc., or 5 gm. per liter. This is roughly 0.05 M., which represents the concentration if no diffusion takes place. Of course the concentration is lowered by diffusion. But the concentrations present may be estimated as:

For $D = 0.5$,	$C = .025$ M. or less;
1.0,	.05 M. or less;
1.5,	.075 M. or less;
2.0,	.10 M. or less;

From Table 38 and the above it is evident that for ten minutes' development (Fig. 52) the concentration of bromide required to prevent fog is less than 0.14 M., and for five minutes' development less than 0.10 M. This corresponds to greater depression for the fog than for the image and is quite in accord with other experimental results.

¹ Sheppard, S. E., and Mees, C. E. K., Investigations, 1. c., p. 41.

If the same laws held for the depression of fog as for the depression of the image, fog would be (in Fig. 53) a straight line function of $\log D$ rather than of D . It may be that diffusion effects account for the difference, as the bromide produced in the emulsion diffuses out and the concentration changes.

It being impossible to separate chemical fog and image density by chemical means, no direct proof of the above is obtainable. However, strong evidence in this direction is afforded by a study of the fog caused by thiocarbamide.

THE FOGGING ACTION OF THIOCARBAMIDE

The practical applications of the action of thiocarbamide have been investigated by Waterhouse and more recently by Perley, Frary, Frary and Mitchell, and others. It was found in general that a hydroquinone developer containing sodium carbonate gives the clearest reversal with thiocarbamide when a careful adjustment of the ingredients of the developer is made. As partial reversal was sufficient for the present purpose, time was not taken to obtain the maximum effect. The developer used was:

Hydroquinone M/20..	5.5 gms.;
Sodium Sulphite.....	50 gms.;
Sodium Carbonate....	15 gms.;
Water to.....	1000 ccs.

The concentration of thiocarbamide was 0.003 M. As it was very difficult to secure consistent results for each determination, eight to sixteen plates were developed under similar conditions and their densities averaged. Even so there are obvious errors. The times of development were such as to give always the same contrast. The curve for hydroquinone in the absence of thiocarbamide was first determined (lowest curve, I., Fig. 54). Curves for the densities due to the

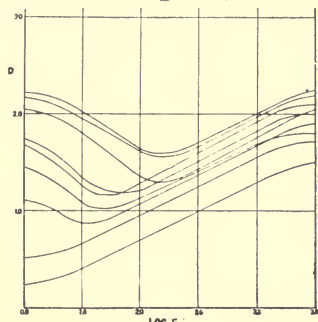

Fig 54

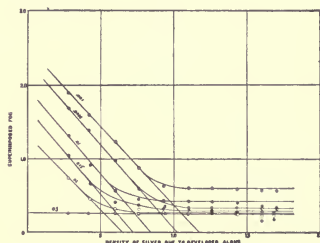

Fig. 55

developer with thiocarbamide were then obtained, using different concentrations of bromide. These (Fig. 54) show the reversal effect, which decreases as more bromide is added.

These data indicate, first, that there is a general deposition of fog over the plate (the plate curve is raised), which is due probably to increased solubility of the silver halide, and general reduction by physical development. It is evident that the fog of the reversed image (as, for example, the density at $\log E = 0.8$) is depressed more by bromide than a density lying higher on the normal image side of the curve. If it is assumed that the hydroquinone develops the same density in all cases, a fact which separate experiments indicate, the difference between any given curve and the curve for the developer alone may be taken as the fog value. When these fog values are plotted against the corresponding image densities—i. e., the densities for the developer alone—the series of curves in Fig. 55, which bear a marked resemblance to those of Fig. 53 (obtained by a different method) results. The only difference between the two sets of curves is that in Fig. 55 the physically developed fog is in constant amount over the plate, as indicated by the horizontal lines. These curves require the assumption that the fog is of two kinds, as already indicated—the fog resulting from physical development, and that causing the reversal effect. The latter is due no doubt to grains in the emulsion which are rendered developable—that is, the thiocarbamide, like some other compounds containing sulphur, has the power of nucleation as previously interpreted. The fog produced in this way appears to be exactly like that formed in the experiment with monomethyl-*p*-aminophenol discussed above, and, similarly, becomes less as the image density decreases. The parallelism is carried still further if the values of the intercepts on the horizontal axis are treated as in the former experiment. These represent the image densities (bromide concentration in the emulsion) required to prevent the fog. But here bromide is in the developer also, so that, as the bromide in the developer is increased, less is required in the emulsion. Consequently the concentrations in the emulsion and in the developer should be added. The concentrations present in the emulsion (see page 146) are found as follows: For the upper curve ($C = 0.001$, Fig. 54), the intercept gives about 1.2 in density, which, as found above, corresponds to a bromide concentration somewhat less than 0.06 M. Listing all these intercept values with corresponding concentrations of bromide we have:

THE THEORY OF DEVELOPMENT

Concentration of bromide in developer = C	Di_0 (Intercept) from Fig. 55	Concentration of bromide in emulsion corresponding to Di_0 = C'	$C + C'$
.001 M.	1.2	.06 M.	.06 M.
.0035 M.	1.0	.05 M.	.05 M.
.01 M.	.8	.04 M.	.05 M.
.015 M.	.7	.035 M.	.05 M.
.02 M.	.6	.03 M.	.05 M.

These values of C' (the concentration of bromide in the emulsion) represent the maximum, as diffusion lowers the concentration to a certain extent.

$C + C'$ is approximately constant and indicates that for the conditions a bromide concentration slightly under 0.05 M. is required to eliminate fog. Experimentally it was found necessary to use 0.03 M. in the developer, which would indicate that 0.01 to 0.02 M. is present in the emulsion.

The consistency of all the data obtained on fog, and especially of the results of particular experiments like the above, lead to the conclusion that fog is distributed over the image in the manner indicated in Figs. 53 and 55. In certain cases general deposition may occur, as with thiocarbamide, sodium sulphite at fogging concentrations, etc., but this may be separated from the general result by the methods shown. Further, it is believed that fogging agents are alike in their action, and that their fogging tendencies are due to their power of nucleation rather than to their reduction potentials, properties which appear to bear no relation to one another.

Various practical considerations, which, however, may not be discussed here, are evident from the above. Since fog may be greatly restrained by the use of bromide, it appears advisable to use high reduction potential developers with sufficient bromide to eliminate fog completely. Fig. 51 shows how the contrast in the lower region of the plate curve (the toe) may be increased if fog is normally present. Except in so far as fog elimination is concerned it is not possible to increase the contrast appreciably by the use of soluble bromides under any normal conditions.

CHAPTER IX

Data Bearing on Chemical and Physical Phenomena Occurring in Development

NOTE—No attempt will be made here to deal with theories of the mechanism of development, nor even to connect fully the data with such theories. Far too little experimental data is available on the questions involved. Such data as have been accumulated are published for the purpose of adding to the information concerning the phenomena and of illustrating the use of the methods herein described.

THE EFFECT OF NEUTRAL SALTS

1. *Potassium Bromide.*

Lüppo-Cramer attempted to explain the restraining action of bromide as a colloid-chemical phenomenon. This view was controverted by Sheppard on the basis of experimental results similar to those recorded in preceding pages. The normal effect of bromide as described is much more logically explained chemically, as has been done by Sheppard, and in this monograph. The laws governing the normal action of soluble bromides have already been stated. However, at high concentrations of bromide new phenomena, which may be analyzed by similar methods, appear.

It has been found that the laws formulated for bromide action cease to hold at concentrations of 0.16 M. or thereabouts. The point at which this departure occurs seems to vary with the developer, and appears more marked the higher the reduction potential of the developer. The latter may be an accidental relation, as monomethylpaminophenol (of high reduction potential) does not show the effect at concentrations as high as 0.64 M. Pyrogallol exhibits it to a very marked degree, and the following results, for some of which curves are shown, illustrate what happens when this developer is used with 1.28 M. bromide (152 gms. per liter). It is remarkable that in this case the developing agent continues to act in the presence of nearly twenty-five times its own weight of bromide.

Fig. 56 gives the plate curves obtained. The times of development, the values of γ , and the fog (F) are given on each curve. Other relations, derived from the above plate curves and other data, will be discussed. Fig. 57 represents the density-gamma curve at $\log E = 3.0$, and Fig. 58, the $D-t_{\text{dev.}}$ curve for the same exposure. Other data obtained follow:

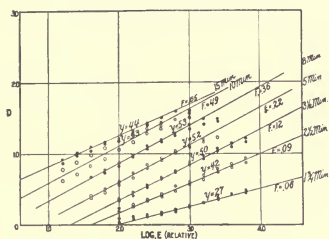

Fig. 56

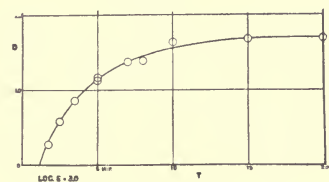

Fig. 58

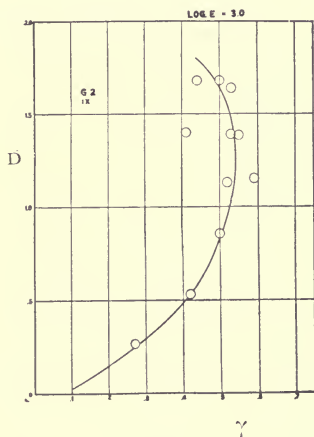

Fig. 57

1. *Intersection of Plate Curves.* There is no common point of intersection of the H. and D. curves at concentrations greater than 0.08 M.—that is, the range of gammas over which this relation holds becomes smaller as the concentration increases.

2. *Density-depression.* As seen from the above, the depression cannot be found by the usual method. This may be determined for an intermediate value of γ , however; and it is found to decrease at concentrations greater than 0.08 M. From the data it is seen that the effect is due to the shift of $\log i$, the inertia constantly decreasing as more bromide is added.

3. *Maximum Contrast.* It is evident that the maximum attainable contrast decreases rapidly as the bromide concentration increases.

4. *Maximum Density.* The maximum densities for the higher exposures ($\log E = 3.0$, etc., see Fig. 56) show normal

relations except that at $C = 1.28$ the value is slightly low. At the low exposures ($\log E = 2.0$) the maximum densities reach a minimum (plotted against the concentration) and then increase with the concentration. The density-time curves for the high exposure ($\log E = 3.0$) are of normal shape, and are fitted by the usual velocity equation. For the low exposure ($\log E = 2.0$ and under) the shape of the $D-t$ curve is changed and after fifteen minutes the density increases more rapidly than for $\log E = 3.0$ for the same time of development.

5. *Fog.* The fog on the unexposed portion of the plate shows normal relations until a concentration of 0.08 M. is reached, after which it increases somewhat.

A careful analysis of these results shows that the new effect of the bromide is evident principally in the low densities, and that it consists in two separate phenomena. First, with pyrogallol the bromide has the same effect as a fogging agent—i. e., it renders a certain amount of silver bromide developable. It is difficult to account for this fact, as it has been observed for no other developer. There is no doubt as to the effect, however, as it was reproducible and consistent. As with normal fog, the high densities (as seen from the normal character of the $D-t$ curve) seem unaffected. Whether or not this is true, the growth of fog does not account entirely for the nature of the plate curves shown. The latter rather strikingly resemble the type of curve obtained for the development of certain papers. It seems probable, therefore, that the potassium bromide reacts on the silver bromide to form a complex, thereby producing in effect a different emulsion. Complex ions result from the dissociation of the new salt, and all the relations are changed as this is formed in larger amounts.

Experiments with other developers lead to similar conclusions, though with them the results are slightly different, especially regarding fog, as noted above. With monomethylparaminophenol no unusual effects were noted even with a bromide concentration of 0.64 M. With bromhydroquinone, paraminophenol, and dimethylparaminophenol, the normal relations fail at about $C = 0.16$ M., and the deposit becomes more and more colored with increasing bromide concentration. With the exception of fog, the effects in general are similar to those for pyrogallol. It is therefore believed that potassium bromide at high concentrations reacts with the silver halide to form a complex of indefinite composition, depending on the concentration. Aside from this there may be absorption

and an effect on the gelatine, but it does not appear that either accounts for the result.

2. Potassium Iodide.

The so-called accelerating effect of potassium iodide and potassium ferrocyanide when added to certain developers is fairly well known. Lüppo-Cramer has described similar results with other neutral salts. To some of these the methods described above have been applied, though this was done more for the purpose of determining the range over which the laws hold than with any intent of investigating the action of neutral salts.

Sheppard and Meyer have also investigated the effect of potassium iodide. Results recorded here may be interpreted in accordance with their conclusions.

It has been found that potassium iodide shows most marked effects with hydroquinone and those developers for which the period of retardation is long. With monomethylparaminophenol and other "fast" developers the accelerating effect, if present, is masked. M/20 dimethylparaminophenol, a developer for which the bromide effect has been especially well established and which appears to be a normal developer, was used in the experiment described. However, this developer shows a short period of induction, so that the experiment does not show the acceleration referred to above. Experiments with other neutral salts illustrate this acceleration, and data for this developer furnish information on less obvious phenomena.

There was little difficulty in applying the methods. A well defined intersection point, which always lay on the log E axis, was obtained. The $D-t$ curves were of normal shape and the constants D_{∞} , K , and t_0 were computed. In the following table the data are summarized.

TABLE 39
Effect of Potassium Iodide on M/20 Dimethylparaminophenol

C_{KI}	a	b	D after 2 minutes	D_{∞}	K	t_0	$\gamma_{\infty} = \frac{D_{\infty} - b}{\log E - a}$
0	.50	0	1.52	2.80	.64	.59	1.47
.005	.82	0	.84	2.60	.27	.46	1.64
.0075	-.40	0	.96	2.60	.33	.48	1.44
.01	.20	0	.70	2.50	.44	.88	1.56
.02	.44	0	.58	2.00	.34	.80	.70
.028	.70	0	.45	.90	.53	.50	.28
.04	1.00	0	.16	0.30	.93	.88	.09

Some of these results are plotted against the iodide concentrations or the logarithms of the concentrations for the sake of emphasis. Fig. 59A shows how different is the relation between D_∞ and $\log C$ for iodide from that for bromide. (In the latter case $D_\infty - \log C$ is a straight line of slope $0.5 = \frac{dD_\infty}{d \log_{10} C}$.)

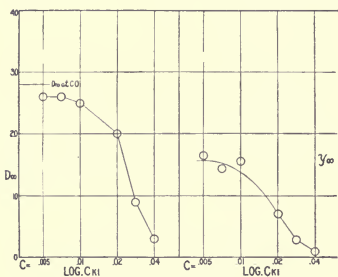

Fig. 59A-B

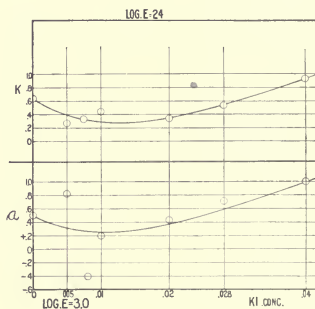

Fig. 60

Fig. 59B shows a still more striking variation from bromide, where γ_∞ is constant and independent of the bromide concentration. In Fig. 60, K and a are plotted against the concentration. Both are constant with bromide. Here both are variable.

3. Other Neutral Salts.

The character of the action of potassium ferrocyanide, potassium oxalate, potassium citrate, potassium sulphate and potassium nitrate was partially investigated. For this purpose a hydroquinone developer was used, the basic formula being:

Hydroquinone M/40 2.75 gms.;
 Sodium Sulphite 3.75 gms.;
 Sodium Carbonate 12.5 gms.;
 Water to 1000 cc.

The constants for the developer alone were determined first, and the neutral salts were then used in the concentrations given below. Table 40 gives the data for the density after six minutes' development (D_6'), D_∞ , K , t_0 (the time required for a density of 0.2 [$t_D = 0.2$], proportional to the time of appearance), and the fog for six and twelve minutes.

TABLE 40
Hydroquinone with additions of neutral salts
Emulsion 3533

Experiment No.	Neutral salt used	Concentration	No Bromide			Used		$tD = 0.2$	F_6'	F_{12}'
			D_6'	D_∞	K	t_0				
197	None83	3.60	.86	4.5	4.3	.38	1.16	
196	$K_4 Fe (CN)_6$.01 M.	1.17	3.80	.77	3.6	3.5	.71	1.60	
198	$K_4 Fe (CN)_6$.05 M.	.91	3.60	.61	3.6	3.7	.40	.95	
200	$K_4 Fe (CN)_6$.25 M.	1.32	3.40	.48	2.2	2.4	.52	.92	
199	$K_2 C_2 O_4 \cdot H_2 O$.25 M.	1.25	3.60	.60	2.8	2.75	.50	.98	
201	$K_3 C_6 H_5 O_7 \cdot H_2 O$.25 M.	.80	3.40	.55	3.7	3.7	.23	.56	
202	$K_2 SO_4$.25 M.	1.36	3.60	.73	3.00	2.7	.56	1.04	
203	KNO_3	.25 M.	1.13	3.60	.55	3.00	2.5	.49	1.08	

It is seen that the period of retardation for the developer alone is very great. ($t_0 = 4.5$ minutes, and the time of appearance is about 4.3 minutes.) Each of the salts used decreases the period of induction, potassium ferrocyanide having the greatest effect, potassium citrate the least. The accelerating effect may also be seen from a comparison of the densities produced in six minutes. Other relations are obvious from the table. It is notable that while t_0 has been changed, the variation of K is less, and D_∞ is practically unchanged. In accordance with the discussion of the effect of bromide on velocity curves (Chapter VII) this means that the neutral salts change the relations for the initial period only. That is, the velocity is practically unaffected in the later stages of the reaction, though the velocity change at the beginning is quite marked.

Therefore we are inclined to attribute the effect of such salts, in distinction from halide salts, principally to physical effects on the gelatine and possibly to adsorption.

THE EFFECT OF CHANGES IN THE CONSTITUTION OF THE DEVELOPER

The developing solution used was hydroquinone with (1) variable alkali concentration; (2) variable sulphite concentration; (3) variable hydroquinone concentration.

The standard formula for hydroquinone used was

Hydroquinone M/20	5.5 gms.;
Sodium carbonate	50 gms.;
Sodium sulphite	75 gms.;
Water to	1000 cc.

All the data were obtained in the usual manner. The results are shown in Tables 41, 42 and 43, and the data for K and D_∞ plotted (for convenience) against the logarithm of the variable concentration are given in Figs. 61, 62, and 63. In each case

the concentrations of two of the constituents of the developer are constant, the other being varied as indicated.

TABLE 41
Hydroquinone Developer with Variation of Sulphite Concentration¹
Emulsion 3533. No bromide. Log $E = 2.4$

Experiment No.	$C_{\text{Na}_2\text{SO}_3}$	a	b	D after 2 min.	D_∞	K	t_0	F after 10 min.	$t_D = .2$	γ_∞
155	6.25	-.40	0	.95	3.80	.54	1.25	.75	1.0	1.35
149	12.5	-.40	0	1.22	3.60	.86	1.6	1.12	.80	1.28
148	25	-.34	0	.80	3.20	1.04	2.20	.76	1.0	1.17
126	50	-.66	0	1.12	3.80	.95	1.80	.99	1.0	1.24
150	75	-.30	0	.83	3.80	.41	1.35	.70	.75	1.41
151	100	-.24	0	.74	4.50	.38	1.65	.67	.75	1.70
156	150	-.40	0	.84	4.00	.52	1.50	.81	.75	1.43

¹ Hydroquinone M/20 (5.5 gm. per liter);
Sodium carbonate 50 gm. per liter;
Sodium sulphite variable.

² Concentration of Na_2SO_3 in grams per liter.

TABLE 42
Hydroquinone Developer with Variation of Carbonate Concentration¹
Emulsion 3533. No bromide. Log $E = 2.4$

Experiment No.	$C_{\text{Na}_2\text{CO}_3}$	a	b	D after 2 min.	D_∞	K	t_0	F after 10 min.	$t_D = .2$	γ_∞
191	4.45	-.20	0	0	4.00	.70	4.0	...	3.3	1.54
157	3.13	+.04	0	0	2.80	.83	5.3	.26	3.7	1.19
158	6.25	-.08	0	0	4.20	.63	4.2	.58	2.75	1.76
159	12.5	-.48	0	.22	3.80	.73	4.0	.64	1.90	1.32
160	25	(-.06)	0	.42	4.40	.72	3.5	.65	1.60	1.79
150	50	-.30	0	.83	3.80	.41	1.35	.70	.90	1.41
161	100	+.04	0	.76	3.60	.75	3.0	.47	.90	1.52
162	200	+.17	0	.21	3.20	.50	5.3	.21	2.00	1.43

¹ Hydroquinone M/20 (5.5 gms. per liter).
Sodium sulphite (75 gms. per liter).
Sodium carbonate variable.

² Concentration of Na_2CO_3 in grams per liter.

TABLE 43
Hydroquinone Developer with Variation of Hydroquinone Concentration¹
Emulsion 3533. No bromide. Log $E = 2.4$

Experiment No.	$C_{\text{Hydroquinone}}^2$	a	b	D after 2 min.	D_∞	K	t_0	F after 10 min.	$t_D = .2$	γ_∞
163	2.75	-.74	0	.26	4.50	.81	4.0	1.10†	1.90	1.45
150	5.5	-.30	0	.83	3.80	.41	1.35	.70†	.25	1.41
164	11.0	-.15	0	.94	3.80	.57	1.69	.42	.65	1.68
169	22.0	-.94	0	0.00	4.40	.50	3.3	.90	3.15	1.31

† Very marked increase in fog.

¹ Hydroquinone variable.
Sodium sulphite 75 gms. per liter.
Sodium carbonate 50 gms. per liter.

² Concentration of hydroquinone in gms. per liter.

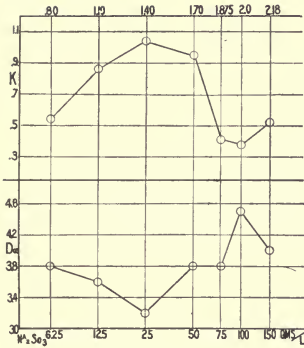

Variable Sulphite
Fig. 61

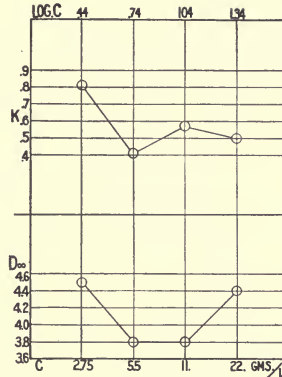

Variable Hydroquinone
Fig. 63

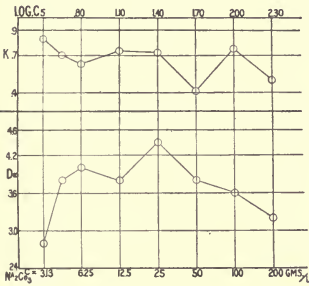

Variable Carbonate
Fig. 62

The results may be summarized as follows:

1. With variable sulphite:

- a is approximately constant;
- $D \infty$ increases with increasing concentration;
- K rises to a maximum and then drops;
- $\gamma \infty$ increases somewhat;

All the other properties—fog, time of appearance, etc.—exhibit unordered variation, showing that they are the result of complex chemical interadjustments.

2. As the concentration of carbonate is increased:

- a decreases to a minimum and then increases, indicating somewhat of a change in speed, though there is irregularity;
- The density developed in two minutes increases rapidly at first and then diminishes;
- $D \infty$ rises to a maximum and falls off;
- K appears to decrease gradually (see curve, Fig. 62);
- $\gamma \infty$ shows unordered variation;

The time of appearance drops to a minimum, after which it increases. This applies to t_0 also.

3. The experiments with hydroquinone are hardly of sufficient range for conclusive evidence. However, it appears that, as the concentration increases:

a increases rapidly (the speed of the plate decreases) and then falls off;

The density developed in two minutes parallels a ;

D_{∞} drops to a minimum and then increases;

K decreases;

γ_{∞} rises to a maximum, then decreases.

The time of appearance and t_0 show the same variation as a . We shall not attempt to explain these effects at this time. It is expected that, later, electrochemical data will be available which will throw light on the chemical reactions involved, which are not clear at present. Even so, a few general conclusions may be presented:

1. There is a variation of plate speed with changing alkali or hydroquinone concentration but not with sulphite;

2. The increase of maximum density with increase of sulphite is probably due partly to the formation of sulphite fog and partly to the fact that the sulphite reacts with the oxidation products with possible regeneration of the developing agent;

3. The effect of alkali apparently consists (aside from chemical considerations) partly in a physical change of the gelatine. The results may be accounted for by a hardening of the gelatine at high concentrations of alkali, which is in accord with work on gelatine.

THE EFFECT OF VARYING THE SULPHITE CONCENTRATION WITH MONOMETHYLPARAMINOPHENOL

When it was found that the maximum density increased with sulphite concentration in the case of hydroquinone, the same experiment was tried with monomethylparaminophenol to determine whether the relations for the relative reduction potentials of the two developers as previously found by the maximum density relations were to be explained on this basis. Three different sulphite concentrations were used. The constants are given in Table 44.

TABLE 44

Variation of Sulphite Concentration with Monomethylparaminophenol*
Emulsion 3533. No bromide. $\log E = 2.4$

Experiment No.	$C_{\text{Na}_2\text{SO}_3}$ (gms./l.)	a	b	D after 2 minutes	D_∞	K	t_0
153	20	+.60	0	1.60	3.10	.43	.37
135	50	0	0	1.66	3.60	.58	.70
152	100	+.24	0	1.44	3.50	.47	.67

The effect is very slight compared with that for hydroquinone for the same concentration range. It therefore appears likely that certain developers like hydroquinone give higher densities than those corresponding to their reduction potentials because of side reactions between the sulphite and the oxidation products.

The above experiments illustrate only partially the range of application of the methods which have been described. Not every phase of this work is new, but considerably more extensive use has been made of those features which appear to be most useful in the study of chemical reactions pertaining to the development process.

* Monomethylparaminophenol M/20 (9 gms. per liter); Sodium carbonate 50 gms. per liter.

CHAPTER X

General Summary of the Investigation, with Some Notes on Reduction Potential in its Relation to Structure, Etc.

REDUCTION POTENTIAL AND THE EFFECT OF BROMIDE ON DEVELOPMENT (ASIDE FROM THE EFFECT ON VELOCITY)

Soluble bromides in a developer offer resistance to its action in any or all of the following ways:

1. As products of a reversible reaction;
2. By lowering the concentration of silver ions available for reduction;
3. By reaction with the silver halide to form complex ions from which the silver is reduced with greater difficulty.

No one of these alone accounts for the magnitude of the observed phenomena, so that probably all are involved. The second is no doubt of most importance at normal concentrations. The third appears to be a decided possibility at higher concentrations of bromide, though no direct data are available.¹

In the absence of the last reaction (No. 3 above), the relations for the measurement of the potential by means of the bromide effect may be formulated from theoretical considerations, the reduction potential being some function of $\log [\text{Br}]$

corresponding to the equilibrium value of $\frac{[\text{Ag.}^+]}{[\text{Ag}_{\text{met.}}]}$ To obtain this

it would be necessary to determine the amount of bromide against which a reducing agent can just develop. But this is not possible, as the oxidation products are unstable and the measure of the energy thus derived depends on time.

The amounts of bromide theoretically required to restrain development completely (i. e., the concentrations against which the developer can just act) may, however, be determined by assuming that the relations which obtain for lower concentrations of bromide hold to the limit. The values so obtained give reasonable results. (See chapter VII.)

¹ With pyro alone a reverse action appeared, i. e., bromide rendered silver bromide more susceptible to reduction.

Otherwise, the actual connection between the chemical theory and the first photographic method used for determining the reduction potential must be sought in general laws and in analogy. It is assumed that:

1. Bromide increases the reaction resistance;
2. The more powerful the developer the greater the concentration of bromide required to produce a given change in the amount of work done;
3. The change in the total amount of work done is measured by the shift of the equilibrium, — i. e., by lowering of the maximum or equilibrium value of the density for a fixed exposure;
4. The reduction potentials of two developers are therefore related to each other in the same way as the concentrations of bromide required to produce the same change in the total amount of work done.

No assumption is made as to the form of the function relating reduction potential and bromide concentration. An arbitrary scale is used, which can be converted when suitable data are available.

Owing to the difficulty of presenting the various related phases of the subject, the proof that the first method (the density depression method as originally suggested by Sheppard) measures the shift of the equilibrium was deferred until Chapter VII. Assuming for the time being that the connection could be established, the action of bromide on the plate curves and all associated effects were investigated.

For theoretical purposes only the straight line portions of the plate curves were considered. For each curve

$$D = \gamma (\log E - \log i) \quad (1)$$

where γ is the slope of the straight line ($= \tan \alpha = \frac{dD}{d \log E}$),

and $\log i$ is the intercept on the $\log E$ axis. $\log E$ has a fixed value throughout.

For a family of such curves (i. e., for plates developed for different times) the following results were obtained;

1. When no bromide is present, and development is not interfered with by a solvent of silver halide, the curves intersect in a point on the $\log E$ axis, that is, $\log i$ is constant. Deviations from this rule are due to errors or to conditions already explained;

2. When sufficient bromide is present the curves intersect in a point below the $\log E$ axis.

Both these rules were first stated by Hurter and Driffield. The new phases of the present investigation, which affords additional proof of these laws, consist largely of a different method of interpretation and a much wider application of the results.

In deducing the various relations, development for different times under fixed conditions was considered as yielding a family of straight lines meeting in a point, the coördinates of which are:

- a. abscissae, $\log E$ units;
- b. ordinates, density units.

The equation for any curve expressed in terms of the coördinates of the point of intersection is

$$D = \gamma (\log E - a) + b. \quad (2)$$

It is easily proved that so long as the straight lines meet in a point the relation between density and gamma is expressed by the equation of a straight line. If the curves do not meet in a point the $D-\gamma$ function is not a straight line.

The $D-\gamma$ curve is therefore the criterion used for a study of effects on the intersection point. The equation for this curve may be written

$$D = \theta (\gamma - A) \quad (3)$$

$$\text{or } D = \theta \gamma - \theta A, \quad (4)$$

and by comparing (2) and (4) it is seen that

$$\theta = \log E - A \quad (5)$$

$$\text{and } b = -A\theta. \quad (6)$$

$$\text{From (5) } a = \log E - \theta. \quad (7)$$

In equation 3, θ is the slope and A the intercept on the γ axis. Equations 6 and 7 show how the coördinates of the point of intersection may be found.

The effects of bromide on a , b and θ were determined, and it was found that:

a is independent of C (the bromide concentration);

b increases negatively as C increases.

Hence the effect of bromide is to lower the intersection point. Accordingly the depression of density may be interpreted as the lowering of this intersection point, and it is obvious that the depression will be independent of γ if a is constant. This may be seen from the expression for the depression—

$$d = -b + b_0 + (a - a_0) \gamma, \quad (8)$$

in which d = depression, and b and b_0 are the ordinates, a and a_0 the abscissae of the point of intersection for bromide and for no bromide, respectively. This equation is developed with no assumption as to the constancy of a , but experimental data have shown that a is constant. Hence $a = a_0$ and $a - a_0 = 0$. Also, b_0 for normal development = 0. Therefore,

$$d = -b \tag{9}$$

and the depression is measured by the normal downward displacement of the point of intersection.

From equation 7, $\theta = \log E - a$. Both $\log E$ and a are constant. Hence θ is constant. Therefore for any given developer, over a considerable range of bromide concentrations, the $D - \gamma$ curve is a straight line of slope θ which is constant for different bromide concentrations. The $D - \gamma$ curves for different concentrations of bromide are therefore parallel.

The relation between the depression of density (or lowering of the intersection point) and the logarithm of the bromide concentration was found to be represented by a straight line for a considerable range. The equation is

$$d = m (\log C - \log C_0), \tag{10}$$

where m is the slope. $\log C_0$, the intercept on the $\log C$ axis, gives the concentration of bromide which is just sufficient to cause a depression.

A number of experiments with different developers and several emulsions demonstrated that m , the slope, is approximately constant.

$$m = \frac{dd}{d \log_{10} C} = 0.5. \quad d = 0.5 (\log C - \log C_0)$$

This indicates that the rate of change of depression with $\log C$ is constant and independent of developer, emulsion and bromide concentration.

Therefore different developers give density depression curves of the same slope (lines parallel to each other), but different values of the intercept, $\log C_0$. A comparison of the intercepts is thus the same as that for the logarithms of the concentrations of bromide required to give the same depression, or the same change in the amount of work done.

If π_{Br} = reduction potential (using Br to indicate determination by the photographic bromide method)

$$\pi_{Br} = k C_0 \tag{11}$$

by arbitrary definition, as the form of the function is not known. Possibly it may be $\pi_{Br.} = k \log C_o$, or some other more involved form. k is intermediate, as the absolute energy can not be measured by present methods. But by referring to a definite standard developer, relative values may be assigned to $\pi_{Br.}$ From the above:

$$\frac{(\pi_{Br.})_x}{(\pi_{Br.})_{Std.}} = \frac{(C_o)_x}{(C_o)_{Std.}} \quad (12)$$

As has been stated, this method measures the shift of the equilibrium, or the change in the amount of work done; and from other considerations it is shown that this method is least subject to error. Consequently the values given are the most reliable data we have on the relative potentials.

THE SPEED OF EMULSIONS

If H is the speed, and E the exposure corresponding to a definite density in the region of correct exposure

$$H \propto \frac{1}{E} \quad \text{or} \quad H = \frac{k}{E} \quad (13)$$

No uniformity exists as to the units in which to express E and as to the value of k . In practice k has been assigned the value 34 and E is expressed in visual c. m. s. (of some definite source). A photographic light unit is needed, and k should be expressed in powers of 10 for greater convenience. Here, $k = 100$ and E is expressed in candle-meter-seconds of acetylene screened to daylight quality.

In accordance with the conceptions relating to the common intersection point, relations for the speed of a plate are worked out in terms of the coördinates of the point. For the general case

$$\log H = \text{Log } k - a + \frac{b}{\gamma} \quad (14)$$

From this it is evident that if b has an appreciable value (i. e., if the inertia changes with γ), the speed depends on the contrast. If $k = 100$ and $\gamma = 1.0$, equation 14 becomes

$$\log H = 2 - a + b. \quad (15)$$

The use of a and b as fundamental constants is advocated. It is shown that the inertia point is not a fixed characteristic of an emulsion.

A few slow emulsions contain bromide, probably absorbed, and give a real value for b . With such emulsions the speed increases with time of development or with γ , as shown by equation 14.

If the developer contains sufficient bromide the effect is the same as if the bromide were in the emulsion.

Experiments show that the speed of a given emulsion may vary widely with the reducing agent used, especially when the latter is of the concentration used in this investigation. The variations of speed observed can not be accounted for by any of the better-known chemical properties of the reducing agent, reduction potential included.

The speed may also be changed by adjustment of the concentrations of the ingredients of the developer.

Most of the phenomena observed are not of practical importance, though further study may reveal methods of advantage.

The practical application of speed determination by the use of the $D - \gamma$ curve is indicated. By this means a and b can be found, and equation 14 or 15 is then used.

THE VELOCITY EQUATION, MAXIMUM DENSITY, ETC.

Five forms of the velocity equation have been considered, and, on applying these to experimental data determined for a wider range of time than usually employed, the following was found to describe most accurately the development process:

$$D = D_{\infty} (1 - e^{K \log t/t_0}) \quad (16)$$

In the logarithmic form this is

$$K (\log t - \log t_0) = \log \frac{D_{\infty}}{D_{\infty} - D}. \quad (17)$$

The constants t_0 , K , and D_{∞} are evaluated by plotting $\log \frac{D_{\infty}}{D_{\infty} - D}$ against $\log t$, such a value of D_{∞} being chosen as will give a straight line when observed values of density are inserted and plotted against the corresponding values of $\log t$. K is then the slope and $\log t_0$ the intercept on the $\log t$ axis.

This equation is selected as giving the most accurate values of D_{∞} , the equation fitting the density-time curve (observed) accurately beyond the initial stage. Other equations fitted the beginning but showed departures after a time. The equation used by Hurter and Driffeld and by Sheppard and Mees, $D = D_{\infty} (1 - e^{-Kt})$, gives values of D_{∞} too low

for almost all developers having an appreciable period of retardation. It fits the data fairly well for a few developers of the "rapid" type—i. e., those with which the time of appearance is extremely short.

The derivative of equation 17 gives an expression for the velocity—

$$\frac{dD}{dt} = \frac{K}{t} (D_{\infty} - D). \quad (18)$$

This opens up new questions as to effects giving rise to such a form, but these can not be answered at present. From other considerations, and from comparison with a more complete equation derived theoretically by Sheppard, it is believed that the velocity is not strictly an inverse function of the time, but that this relation represents an approximation to various correction factors of which we have no definite knowledge. See Sheppard's equation, Chapter V.

It is evident that development can not be described by the simple first order velocity equation except in a very few special cases. Equation 16 includes these cases and is of much more general application.

The method of determining the maximum density curve for a given emulsion and developer is also described. D_{∞} is computed for different values of $\log E$ in the region free from fog (the higher exposures) and plotted against the corresponding values of $\log E$. If the point of intersection is known the straight line and upper portion of the curve may be drawn.

Equation 2 above may be assumed to hold to limiting values of D and γ . Hence,

$$D_{\infty} = \gamma_{\infty} (\log E - a) + b$$

$$\text{and} \quad \gamma_{\infty} = \frac{D_{\infty} - b}{\log E - a}. \quad (19)$$

This gives a new method for the computation of the limit of contrast to which a plate can be developed. It is shown that this limit can not be reached practically because of fog.

The method of computing γ_{∞} given (equation 19) yields much more consistent and accurate values than is possible by the method of Sheppard and Mees,¹ and it imposes no restrictions on the times of development, nor on the values of γ necessary for the plates used. Several weaknesses of the older method also become apparent. The equation $D = D_{\infty} (1 - e^{-Kt})$ was used. γ was substituted for D on the

¹ Sheppard, S. E. and Mees, C. E. K., Investigations, 1. c., pp. 65 and 293.

assumption that γ is proportional to D (i. e., the H. and D. straight lines meet in a point on the log E axis). From two equations for t_1 and t_2 where $t_2 = 2t_1$, the result was

$$\gamma_{\infty} = \frac{\gamma_1}{1 - e^{-Kt_1}} = \frac{\gamma_2}{1 - e^{-Kt_2}},$$

from which

$$K = \frac{1}{t} \log_e \frac{\gamma_1}{\gamma_2 - \gamma_1}.$$

Others have attempted to apply this to all cases, and the reasons for its failure are now quite clear. If bromide is present in emulsion or developer, D may not be replaced by γ as was done, for from equation 3 $D = \theta(\gamma - A)$ for such a case. Also, the equation $D = D_{\infty}(1 - e^{-Kt})$ holds only approximately for a very limited class of developers when used without bromide. Consequently the equation fails to give consistent results when there is the slightest departure from the restrictions placed upon it.

There is definite experimental evidence that D_{∞} varies with the developer. (See Chapter VI, Tables 18, 19, 20 and 21.) It is believed that in the absence of side reactions which complicate the result, the maximum density D_{∞} tends to be greater the higher the reduction potential of the developer. The most marked exceptions are hydroquinone and its halogen substitution products. It is known that in the case of hydroquinone sodium sulphite and sodium carbonate react with the oxidation products, resulting in a regeneration of the reducing agent, possibly according to this scheme:—

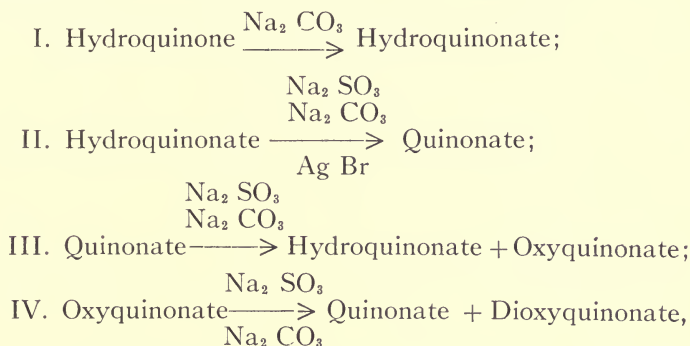

as found by Luther and Leubner. Therefore the hydroquinone compounds are capable of yielding a higher value for the equilibrium point than is normally the case.

Further, increase of sulphite in the hydroquinone developer increases the maximum density (see Chapter IX), which is not the case with monomethylparaminophenol.

If the hydroquinones are excluded, other developers, classified according to their equilibrium densities, stand approximately in the order of their reduction potentials.

γ_{∞} depends not only on D_{∞} (equation 19), but also on a . The latter is the principal factor in plate speed which shows no regular variation with the developer. Hence, in general, γ_{∞} does not vary with the reduction potential of the developer, though it may do so in a certain class of compounds which are relatively free from the type of complicating reactions already mentioned.

Certain groups of developers show approximately the same retardation time and the same value of K . Within such a group the resistance factor of the Ohm's law analogy may be considered as constant. Hence the relative velocities are measures of the relative reduction potentials, or at least approximate them.

$$\text{Velocity} = \frac{\text{Potential}}{\text{Resistance}}. \quad (20)$$

and if $R_1 = R_2$

$$\frac{\text{Potential}_1}{\text{Potential}_2} = \frac{\text{Velocity}_1}{\text{Velocity}_2} \quad (21)$$

The various terms of the resistance (see Chapter I, p. 22) are included in the reaction resistance as indicated by t_0 and K , and for the same emulsion other possible terms of the numerator in equation 20 are the same. The resultant comparison by equation 21 may not give a true numerical result for the relative potential, but it will be of the right order.

An additional classification of certain compounds was made by this method, this placing them in approximately the same order as that obtained by preceding data.

It is indicated that the curve corresponding to the latent image fully developed, with no reduction of unaffected grains, may lie below such maximum density curves as may be obtained from preceding methods. It is possible also that in some cases the latent image is not fully developed, but it is believed that in general the number of grains affected by light, and considered as units of the latent image, may be less than the number actually developed. This accounts partially for

the small amount of energy required to produce a developable image. However, no experimental proof of this hypothesis is available.

Considerable data were secured on the effect of soluble bromide on the velocity curves and on the maximum density. If the bromide concentration is increased with a certain developer, and if D_∞ as determined for each concentration is plotted against the logarithm of the corresponding concentration ($\log C$), a straight line is obtained, as for the density depression. The equation for this curve is

$$D_\infty = -m(\log C - \log C'_0), \quad (22)$$

where $-m$ is the slope, $\log C'_0$ is the intercept on the $\log C$ axis, and C'_0 represents the concentration of potassium bromide theoretically required to prevent development, or the concentration against which the developer can just act.

It is shown (Chapter VII) that the slope of the $D_\infty - \log C$ curves is very nearly the same as that for the $d - \log C$ curves, except that the former is negative.

The mean of thirty determinations gave 0.50 as the value of

$$\frac{dd}{d \log_{10} C} = - \frac{dD_\infty}{d \log_{10} C} = m.$$

Consequently, different developers yield $D_\infty - \log C$ curves which are parallel, as for the depression curves. A comparison of the intercepts is therefore a measure of the reduction potential, assuming that the latter varies with the concentration of bromide against which the developer can just function. (See Chapter I.) As it is neither necessary nor convenient to compare the intercepts, the concentrations of bromide at which the same D_∞ was produced were compared. (This is the same as comparing the intercepts.) This classification of developers gives results which on the whole are comparable (as to order) to those of the depression method.

It is shown that this method is affected by the possibility that a developer may give maximum densities higher than those corresponding to its reduction potential, as in the case of the method of equilibrium values and the velocity comparison.

While D_∞ varies with the bromide concentration, γ_∞ is constant and independent of C . (See Chapter VII, Tables 26 and 27.)

It is proved (Chapter VII, p. 127), that the density depression measures the shift of the equilibrium, or that the lowering of the maximum density is the same as the depression of the intersection point. From equation 19

$$\gamma_{\infty} = \frac{D_{\infty} - b}{\log E - a}$$

γ_{∞} , $\log E$, and a are constants, and D_{∞} and b vary at the same rate with $\log C$. Hence $D_{\infty} - b = \gamma_{\infty} (\log E - a) = \text{constant}$ and the change in $-b$ equals the change in D_{∞} for a definite increment in $\log C$. The change of $-b$ from $C = 0$ to $C = X$ is d ($d = -b$) and is equal to the shift of the density equilibrium point or $(D_{\infty})_0 - (D_{\infty})_x$. This may be written

$$-b = d = (D_{\infty})_0 - (D_{\infty})_x \quad (23)$$

which means that the law of density depression applies also to the limiting value of the density. This relation confirmed by experiment, places the first (density depression) method for determining the reduction potentials on a much firmer basis.

Bromide has no effect on K , the velocity constant (Chapter VII, Table 30).

t_0 of the velocity equation and t_a the time of appearance, are found to be straight-line functions of the concentration of bromide, C . The relations are

$$(t_0)_x = kC + (t_0)_0, \quad (24)$$

where $(t_0)_x$ is the value at the concentration x , and $(t_0)_0$ that for $C = 0$. For the time of appearance

$$(t_a)_x = k'C + (t_a)_0. \quad (25)$$

From complete data for two developers used with many different concentrations of bromide, and averaged data from smoothed curves for all the functions as now determined, it may be shown that the only effect of bromide on the velocity is a change during the period of induction—i. e., at the beginning. After a time the velocity becomes independent of the bromide concentration (See Chapter VII, Figs. 42 and 47.)

The effect of bromide on the curves (a downward normal displacement of the curve beyond the initial period), which is equal to the depression, d , may be expressed mathematically as

$$d = D_{\infty 0} - D_{\infty x} = D_0 - D_x = D_{\infty x} (e^{K \log t_{0x}/t_{00}} - 1). \quad (26)$$

This signifies that the density depression d is normally not only independent of γ , but beyond the initial stage is inde-

pendent of the time of development also. Practically this statement requires careful analysis, because while the depression is in a sense independent of γ and of t even at the beginning, the value of $D_o - D_x$ (the actual difference between the densities obtained for $C = 0$ and $C = X$ at a definite time during the early stage) is not independent of the time of development. The discrepancy is due entirely to the period of induction, but it should be remembered that the ordinary useful values of γ may be obtained entirely within this period. It is emphasized again that equation 26 applies only to the range of unchanged velocity.

The relation between the maximum densities corresponding to $C = 0$ and to $C = X$ was found to be

$$D_{\infty} e^{K \log t_{ox}/t_{oo}} = D_{\infty o}. \quad (27)$$

The combination of equations 26 and 27 with others preceding gives rise to new and complex relations which have not been thoroughly analyzed.

THE FOGGING POWER OF DEVELOPERS AND THE DISTRIBUTION OF FOG OVER THE IMAGE

The term "emulsion fog" is used for the deposit resulting from the development of grains which contain nuclei and are consequently capable of reduction before the developer is applied. These nuclei may result from the action, during or after the making of the emulsion, of light, of chemical substances possessing the power of rendering the grains developable, or from radio-activity.

It is supposed that emulsion fog forms a relatively small proportion of the total deposit usually referred to as chemical fog, but this is not known. The two can not be separated. It is evident that the developer may play a large part in determining to what extent development of emulsion fog takes place. It is possible, however, that in addition to the reduction of these previously nucleated grains, new grains in the emulsion are rendered developable by some specific action of the reducing solution. The term chemical fog is applied more strictly to the deposit resulting from the latter cause.

Chemical fog may be produced by physical or chemical development, and may show differences from the image in structure and in grain distribution.

For the present, studies of fog must be confined to the total effect, from whatever cause. It is pointed out, however, that

the complex nature of the fog production probably accounts for the fact that the relations for fog are different from those for the image.

Fog tends to a definite limit or equilibrium density. The growth of fog with time was found to be described quite accurately by the equation

$$D = D_{\infty} (1 - e^{-K(t-t_0)}), \quad (28)$$

where D_{∞} is the ultimate or equilibrium density and t_0 the time at which fogging begins. The fogging velocity is

$$\frac{dD}{dt} = K (D_{\infty} - D). \quad (29)$$

Accordingly, the growth of the image and that of the fog do not appear to follow the same law. (Compare equation 16 and 18 with 28 and 29.) Equation 28 is the first order reaction law corrected for a period of delay. It is probable that most of the fog results from physical development and that the process is therefore freed from some of the restrictions imposed on the development of the image, where the grains are fixed in place and have a definite distribution, and the gelatine plays a part. Fog does not vary with reduction potential nor with other common properties of a developer. (See Chapter VIII, Table 36.)

It is difficult to find a quantitative expression for fogging power. The best, and one which indicates fairly well the relative amounts of fog obtained in a definite time, is obtained by using the fogging velocity at an intermediate time, such as ten minutes. (See Chapter VIII, Tables 35, 36, 37).

The character of the possible action of fogging agents is indicated by the fact that with thiocarbamide the developer reduces, in the presence of the fogging agent, no more grains than it does alone. Other indirect evidence indicates that fogging agents have the power of nucleation, and that this action is increased by increased solubility of the silver halide. The fogging agent may therefore be considered as rendering developable and reducing grains which the developing agent can not effect. That this is not a matter of reduction potential is quite certain. The developing agent may have the same power of nucleation, which means that very pure reducing agents of low reduction potential may produce much fog.

The distribution of fog over the image was studied from the standpoint of preceding work, and it was found that fog is practically absent from the high densities, but increases as

the image densities decrease. Experimental data interpreted in the light of the general laws for the growth of the image and the effect of bromide led to the equation

$$F = k (D_i - D_{i_0}) \quad (30)$$

for the fog. D_i is the density of the image corresponding to the fog F , and D_{i_0} is the density required practically to prevent fog (i. e., the growth of this density is rapid enough so that the free bromide formed prevents fog). Equation 30 is a straight line of slope k , and k is apparently equal to unity.

The fogging action of thiocarbamide was studied and found to be apparently the same as that of ordinary fogging agents or developers giving fog. Results obtained here, as well as the work on the concentration of bromide present after development, confirmed equation 30.

Direct and indirect evidence indicates that fog is more restrained by bromide than is the image. This indicates also that most fogging agents are of relatively low reduction potential.

Further investigation by similar methods should yield valuable results on phenomena of fundamental importance.

DATA BEARING ON CHEMICAL AND PHYSICAL PHENOMENA OCCURRING IN DEVELOPMENT

The effect of neutral salts, potassium bromide,
iodide, ferrocyanide, etc.

From experiments with pyrogallol and other developers at very high concentrations of bromide it was concluded that at such concentrations bromide has a dual effect:—

1. It appears to act like a fogging agent in that new grains are rendered developable;
2. It probably forms complexes with the silver bromide, giving new characteristics to the emulsion.

The two effects are no doubt related. That the result is not due primarily to action on the gelatine is indicated by the fact that for the higher densities the velocity curve is of the normal shape and the velocity is not greatly changed.

The so-called "acceleration" of development produced by certain neutral salts, such as potassium iodide, was investigated by the usual methods. Potassium iodide was especially studied, and its effects were found to be quite different from those of bromide or of the other neutral salts used. (See Chapter IX, Figs 59 and 60.) This is undoubtedly due to a reaction with the silver halide.

Acceleration by other neutral salts may be attributed to effects on diffusion and to adsorption of the developer.

The period of induction is shortened by these salts, but the velocity beyond this period is not greatly changed and the maximum density is not affected.

All the results described depend upon the character of the emulsion used.

The effects of changes in the constitution of the developing solution are detailed for hydroquinone, and less extensively described for monomethylparaminophenol. The bearing of these results is indicated.

RELATIONS BETWEEN REDUCTION POTENTIAL AND PHOTOGRAPHIC PROPERTIES

Although the present investigation offers more quantitative data on both the reduction potentials and the photographic properties of developers than have hitherto been available, it is still insufficient to permit the formulation of general rules. With the methods well in hand, it should be possible to obtain the information necessary. At present a few relations which appear well founded may be emphasized:

The degree to which a developer is affected by bromide depends on its reduction potential. If a developer is of low potential, a given amount of bromide will have a greater effect in lowering the density than if the developer has a high potential. This is exclusive of the effect of bromide on the fog (if the latter is appreciable), which may be an important practical consideration.

The speed of an emulsion varies with the reducer, but this is apparently no function of the reduction potential. A careful study of the data shows that even if reducers of low fogging power only are considered, (so that the fog error is minimized), the speed does not vary with the reduction potential.

If high contrast is desired and prolonged development is necessary to secure it, it is desirable to use bromide to prevent fog. Under these conditions, a higher effective plate speed can be secured from a high reduction potential developer with as much bromide as may be necessary to eliminate fog.

















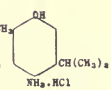





The maximum density tends to increase with increasing reduction potential.

Because of the interrelation of speed and maximum density, the maximum contrast shows no regular variation with reduction potential.

THE THEORY OF DEVELOPMENT

TABLE 45

Summary of Reduction Potential Values

				
Red. Pot.	1.0	7 (?)	0.4	6.0
Nuclear methylation				  
	2.2			$\text{NH}_2 \cdot \text{H}_2\text{SO}_4 / 2$ 7 $\text{NH}_2 \cdot \text{HCl}$ 9+ $\text{NH}_2 \cdot \text{HCl}$ lower than p-a-p
Side-chain methylation				 
	0.CH3	3.8	$\text{NH} \cdot \text{CH}_2$ $\text{NH}_2 \cdot \text{HCl}$	$\text{NH} \cdot \text{CH}_3 \cdot \text{H}_2\text{SO}_4 / 2$ 20 $\text{NH} \cdot \text{C}_6\text{H}_5$ lower than p-a-p
84 reactive group	 greater than 1  7  21	 16  11  21(?)	 30 to 40  6 (?)	 23 $\text{NH} \cdot \text{CH}_3 \cdot \text{H}_2\text{SO}_4 / 2$  1.8 $\text{NH}_2 \cdot \text{CH}_2\text{COOH}$  less than p-a-p  less than 1

Apparently no relation exists between the time of appearance of the image and the reduction potential. t_a is an indicator of the diffusion rate and the reaction resistance, neither one of which is necessarily influenced by the potential.

No constant relation exists between K , the velocity constant, and the potential. For developers of practically the same resistance factors, the velocity varies approximately as the potential—i. e., it increases with increasing π_{Br} .

The fogging power of developers is not a function of the reduction potential.

Other relations which form the basis for the measurement of reduction potential are not included here, as they have been discussed.

It is evident that factors other than the potential control the developing properties of organic reducers. Hence the ordinary practical working properties of a developer are neither safe nor generally useful criteria of its relative energy.

REDUCTION POTENTIAL AND CHEMICAL STRUCTURE

Table 45 gives the only quantitative measurements obtained on the relation between structure and reduction potential. It will be remembered that the values given are based on a comparison of the developers at the concentration $M/20$, with the same concentrations of sulphite and carbonate throughout.

A survey of the table indicates that the effect on the energy produced by the various substitutions, (mentioned in Chapter I., in connection with the rules of Lumière and of Andresen), is not as readily predicted as these rules would indicate. Although it will be necessary to measure many more compounds before generalizations can be made, certain tendencies are clear.

It is evident that the aminophenols are most energetic, the hydroxyphenols next, and the amines the least, the amount of reactive energy depending on the number and position of the active groups. It is consistently the case where only two active groups are concerned, and if three groups are concerned the measurements and experiments with other compounds show that a mixture of hydroxyl and amino groups imparts greater energy to the substance.

The introduction of a single methyl group in the nucleus or in an amino-group increases the energy.

Substitution of two methyl groups for the hydrogen of an amino-group appears to be of doubtful advantage over the

preceding. Contrary to Lumière, we find dimethylparaminophenol to be a developer, and of greater energy than paraminophenol, though lower than the monomethyl substitution compound.

Nuclear substitution of a halogen in the hydroxy-phenols raises the energy.

The series of substituted paraminophenols was especially studied and additional relations are shown. In addition to those already stated the following may be given:

In the case of nuclear methylation (one methyl group only) the energy is increased, but the increase depends on which position the methyl group occupies with respect to the other groups. (See paramino-orthocresol and paramino-metacresol. The latter has undoubtedly greater energy.)

Paraminocarvacrol has a much lower potential than paraminophenol, which would indicate that further methylation or increase in the size of the molecule in that direction is undesirable. Benzyl paraminophenol gives a result which may be questioned, and which should therefore be studied further. (The energy is lowered by the substitution of a phenyl group in the amino group.)

Introduction of another amino group greatly increases the energy.

Chlorination of paraminophenol appears of doubtful advantage.

Simultaneous nuclear and side chain methylation (one methyl group for each) appears to give greater energy than either substitution alone.

Change to a glycine lowers the potential, as does also the introduction of a $-\text{CH}_2\text{OH}$ group.

These results apply to the groups only in the positions shown. Present data do not warrant further deductions, especially in view of the fact that the influence of the position of the groups is not yet known.

Many fallacies in the published results of previous investigations have come to light during the present investigation. It is now quantitatively proved that while developers differ in their action, and some have objectionable features, there is a considerable number of developers which when properly used are capable of giving identical results. It is very often true that a greater change in results may be brought about by altering the relative concentrations of the ingredients of the developing solution than by using a different reducing agent.

The action of bromide has been dealt with at length, and some of its practical applications have been pointed out. If bromide is used in accordance with the principles recorded above, there is no doubt of its being of real advantage for much photographic work.

Bibliography

GENERAL REFERENCES

- ANDRESEN, M., Das latente Lichtbild. (Knapp, Halle a. S., 1913.)
EDER, J. M., Ausführliches Handbuch für Photographie, vol. V., p. 288. (Knapp, Halle a. S., 1905.)
———, ———, Beiträge zur Photochemie. (Knapp, Halle a. S., 1904.)
HÜBL, A., Entwicklung. (Knapp, Halle a. S., 1901.)
LÜPPO-CRAMER, Neue Untersuchungen zur Theorie der photographischen Vorgänge. Phot. Korr. **49**: 262, 310, 355, 440. 1912; **50**: 135. 1913.
LUTHER, R., Die chemischen Vorgänge in der Photographie. (Knapp, Halle a. S., 1899.)
MELLOR, J. W., Chemical Statics and Dynamics. (Longmans, London, 1904.)
NERNST, W., Theoretische Chemie. Seventh Edition. (Enke, Stuttgart, 1913.)
OSTWALD, W., Outlines of general chemistry. (Macmillan, London, 1890.)
SHEPPARD, S. E., and MEES, C. E. K., Investigations on the theory of the photographic process. (Longmans, London, 1907.)

THE CONSTITUTION OF DEVELOPING AGENTS AND THEIR PHOTOGRAPHIC PROPERTIES

- ANDRESEN, M., Bromhydroquinone als Entwickler. Phot. Korr. **36**: 396. 1899.
———, —., Charakterische Reaktionen der bekannteren Entwickler-substanzen. Phot. Korr. **35**: 12, 106. 1898.
———, —., *Constitution der Entwickler. Phot. Mitt. pp. 124, 286, 296. 1891; Farbenindustrie, p. 187. 1889.
———, —., Constitution organischer Entwickler. Jahrb. Phot. **7**: 418. 1893.
———, —., Das Wasserstoffsperoxyd im Dienste der Photographie. Phot. Korr. **36**: 260. 1899.
———, —., Die Isomeren des Amidols. Phot. Korr. **31**: 505. 1894.
———, —., Organische Entwicklersubstanzen. Jahrb. Phot. **7**: 486. 1903.
———, —., Verwendung von Derivaten des *p*-Phenylendiamins, sowie des *p*-Toluyldiamins als Entwickler in der Photographie. Jahrb. Phot. **9**: 50. 1895.
———, —., Weitere Beiträge zur Kenntniss des Diamidooxydiphenyls als Entwickler. Phot. Korr. **36**: 208. 1899.
———, —., Zur Charakterisierung der Entwicklersubstanzen. Phot. Korr. **36**: 635, 1899.
———, —., Zur Chemie der organischen Entwickler. Phot. Korr. **37**: 185. 1900.
DENZEL, W., and WEINLAND, R. F., Compounds of pyrocatechol and of phenol with alkali and alkaline earth salts of various acids. Chem. Abst. **9**: 319. 1915.
DESALME, J., On a new developer, Sulfinol. Brit. J. Phot. **59**: 425. 1912.

* An asterisk is used to designate those citations which it has not been possible to check, and which may, therefore, be incomplete or incorrect.

- EDER, J. M., Ausführliches Handbuch der Photographie, vol. V., p. 288. (Knapp, Halle a. S., 1903.)
- GAYLORD, W. K., and NOYES, A. A., Ueber den Einfluss der Einführung einer Sulphogruppe auf das Entwicklungsvermögen. *Jahrb. Phot.* **8**: 19. 1894.
- HOMOLKA, Beitrag zur Theorie der organischen Entwickler. *Phot. Korr.* **51**: 256, 471. 1914.
- , The latent image and development. *Brit. J. Phot.* **64**: 81. 1917.
- KÖNIG, E., and Staehlin, O., Ueber Triamidobenzol und Triamidotoluol als Entwickler. *Jahrb. Phot.* **21**: 52. 1907.
- LEIPPER, A. D., Photographic developers. *Brit. J. Phot.* **47**: 826. 1900.
- LIESEGANG, E., Die Constitution der organischen Entwickler. Photochemischen Studien, vol. II. Düsseldorf, 1894.
- LOBEL, L., Der Ersatz der Alkalien durch Ketone und Aldehyde in den photographischen Entwicklern. *Jahrb. Phot.* **8**: 103. 1904.
- LUMIÈRE, A., and L., and SEYEWETZ, A., Amines in the developer. *Brit. J. Phot.* **45**: 806. 1898.
- , —, —, —, —, Benzaminosemikarbazide. *Jahrb. Phot.* **18**: 453. 1904.
- , —, —, —, —, Die Bildung von Salzen mit Entwicklerfähigkeit aus Aminen und Phenolen. *Jahrb. Phot.* **13**: 306. 1899.
- , —, —, —, —, On the developing power of hydroquinone substitution compounds. *Brit. J. Phot.* **61**: 341. 1914.
- , —, —, —, —, Sur les substitutions alkylées dans les groupes de la fonction developpatrice. *Bull. soc. franç. phot.* II. **14**: 158. 1898.
- , —, —, —, —, Ueber die Additionsprodukte, welche die Gruppen mit entwickelnden Eigenschaften mit den Aminen und Phenolen bilden. *Arch. wiss. Phot.* **1**: 64. 1899.
- , —, —, —, —, Ueber die Verbindungen der Entwicklerbasen mit schwefliger Säure. *Jahrb. Phot.* **21**: 473. 1907.
- , —, —, —, —, Ueber eine neue Gruppe von Entwicklern aus der dromatischen Reihe. *Jahrb. Phot.* **9**: 62. 1895.
- , —, —, —, —, Ueber die entwickelnden Eigenschaften einer neuen Verbindung von Hydrochinon und Paraphenyldiamin (Hydramin). *Arch. wiss. Phot.* **1**: 89. 1899.
- , —, —, —, —, Ueber die Konstitution der reduzierenden Substanzen, die das latente Bild ohne Alkali entwickeln können. *Jahrb. Phot.* **18**: 99. 1904.
- , —, —, —, —, Untersuchungen über die chemische Konstitution der Entwickler-Substanzen. *Jahrb. Phot.* **12**: 100. 1898.
- LÜPPO-CRAMER, Ueber das Entwicklungsvermögen des Hydrosulfits für Jodsilbergelatine. *Phot. Korr.* **45**: 405. 1908.
- RENGER-PATZSCH, R., Versuche mit Metolentwickler ohne Alkali. *Phot. Rund.* **25**: 286. 1911.
- SÜSZ, A., Lithiumkarbamid. *Jahrb. Phot.* **18**: 453. 1904.
- VALENTA, E., Bemerkungen zu der Erwiderung des Herrn Loebel auf meinen Artikel: Diamidophenolnatrium als Entwickler für Bromsilbergelatine. *Phot. Korr.* **42**: 171. 1905.
- , —, Das Sulfinol als Entwickler für Bromsilbergelatine Trockenplatten. *Phot. Korr.* **52**: 26. 1915.
- , —, 4-Oxyphenylmethylglycin als Entwicklersubstanz. *Phot. Korr.* **52**: 90. 1915.
- , —, Ueber die Verwendbarkeit von Diamidophenolnatrium zur Entwicklung von Bromsilbergelatine Trockenplatten. *Jahrb. Phot.* **19**: 122. 1905.
- VAUBEL, W., Pyrogallolentwickler. *Jahrb. Phot.* **18**: 448. 1904.

- VOTECEK, E., Ueber das Verhalten der Hydrazine zu dem photographischen Lichtbilde. *Phot. Korr.* **35**: 458. 1898; *Arch. wiss. Phot.* **1**: 73, 1899; *Jahrb. Phot.* **13**: 98, 515. 1899.
- WATERHOUSE, J., Amines as accelerators. *Brit. J. Phot.* **45**: 846. 1898.
- WATKINS, A., Some developers compared. *Phot. J.* **40**: 221. 1900.

THEORY OF REDUCTION POTENTIAL AND EFFECT OF BROMIDES

- ABEGG, R., Zur Frage nach der Wirkung der Bromide auf die Entwickler. *Jahrb. Phot.* **18**: 65. 1904.
- ARMSTRONG, H. E., The chemical changes attending photographic operations. I. The theory of development in relation to the essentially electrolytic character of the phenomena and the nature of the photographic image. *Brit. J. Phot.* **39**: 276. 1892.
- BANCROFT, W. D., The effect of bromide. *Brit. J. Phot.* **59**: 878. 1912. Ueber Oxydationsketten. *Zeits. physik. Chem.* **10**: 387. 1892.
- BOGISCH, A., Reductions und Entwicklungsvermögen. *Phot. Korr.* **37**: 89, 272. 1900.
- BREDIG, G., Die electromotorische Scala der photographischen Entwickler. *Jahrb. Phot.* **9**: 19. 1895.
- FRARY, F. C., and NIETZ, A. H., The reaction between alkalies and metal and hydrochinon in photographic developers. *J. Amer. Chem. Soc.* **37**: 2273. 1915.
- , —, —, —, The reducing power of photographic developers as measured by their single potentials. *J. Amer. Chem. Soc.* **37**: 2246. 1915.
- HURTER, F., and DRIFFIELD, V. C., The action of potassium bromide. *Phot. J.* **38**: 360. 1898.
- LUMIÈRE, A., and L., and SEYEWETZ, A., Wirkung von Chinonen und ihrer Sulfoderivate auf photographischen Silberbilder. *Chem. Ztg.* **34**: 1121. 1910.
- LÜPPO-CRAMER, Die verzögernde Wirkung der Bromide in den photographischen Entwicklern als kolloidchemischer Vorgang. *Koll. Zeits.* **4**: 92. 1909.
- , —, Ueber den Einfluss der Bromide im Entwickler auf die topographische Verteilung des Silbers im Negativ. *Phot. Korr.* **49**: 383. 1912.
- LUTHER, R., Die chemische Vorgänge in der Photographie. (Knapp, Halle a. S., 1899.)
- MATTHEWS, J. H., and BARMEIER, F. E., The electro-potentials of certain photographic developers and a possible explanation of photographic development. *Brit. J. Phot.* **59**: 897. 1912.
- SHEPPARD, S. E., Gegen Dr. Lупpo-Cramer's Auffassung der verzögernden Wirkung der Bromide in den photographischen Entwicklern als kolloidchemischer Vorgang. *Koll. Zeits.* **5**: 45. 1909.
- , —, Reversibility of photographic development and the retarding action of soluble bromides. *J. Chem. Soc.* **87**: 1311. 1905.
- , —, Theory of alkaline development, with notes on the affinities of certain reducing agents. *J. Chem. Soc.* **89**: 530. 1906.

PHOTOGRAPHIC THEORY

- ABEGG, R., Eine Theorie der photographischen Entwicklung. *Arch. wiss. Phot.* **1**: 109. 1899.
- , —, Theorie des Eisenentwicklers nach Luther. *Arch. wiss. Phot.* **2**: 76. 1900.

- ANDRESEN, M., Zur Theorie der Entwicklung des latenten Lichtbildes. *Phot. Korr.* **35**: 445. 1898.
- BANKS, E., The theory of development. *Brit. J. Phot.* **43**: 677. 1896.
- BENNETT, H. W., Control in development. *Phot. J.* **43**: 74. 1903.
- BLOCH, O., Plate speeds. *Phot. J.* **57**: 51. 1917.
- BOTHAMLEY, E. H., Remarks on some recent papers concerning the latent photographic image and its development. *Phot. J.* **39**: 123. 1899.
- DESALME, J., The chemical theory of development. *Brit. J. Phot.* **57**: 653. 1910.
- DRIFFIELD, V. C., Control of the development factor and a note on speed determination. *Phot. J.* **43**: 17. 1903.
- FRIEDLAENDER, J. H., Zur Theorie der Entwicklung. *Phot. Korr.* **39**: 252. 1902.
- KINGDON, J. C., On the causes of the variation of the Watkins factor for different developers. *Phot. J.* **58**: 270. 1918.
- KROHN, F. W. T., The mechanism of development of the image in a dry plate negative. *Brit. J. Phot.* **65**: 412. 1918.
- LUMIÈRE, A. and L., and SEYEWETZ, A., Distinguishing by means of development between images in chloride and bromide emulsion. *Brit. J. Phot.* **58**: 299. 1911.
- , —, —, —, —, On the comparative reducing power of the principal developers. *Brit. J. Phot.* **56**: 627. 1909.
- LÜPPO-CRAMER, Ueber die Veränderung der Kornform der Bromsilbers bei der Reduktion und die Nährkörnertheorie der Entwicklung. *Phot. Korr.* **48**: 547. 1911.
- , —, Zur Theorie der chemischen Entwicklung. *Phot. Korr.* **35**: 266. 1908.
- LUTHER, R., Physical chemistry of negative Processes. *Phot. J.* **52**: 291. 1912.
- MEES, C. E. K., Time development. *Phot. J.* **50**: 403. 1910.
- , —, and PIPER, C. W., The fogging power of developers. *Phot. J.* **51**: 226. 1911; **52**: 221. 1912.
- PIPER, C. W., The application of physico-chemical theories in plate-testing and experimental work with developers. *Brit. J. Phot.* **60**: 119. 1913.
- RENWICK, F. F., The physical process of development. *Brit. J. Phot.* **58**: 75. 1911.
- SCHAUM, K., Zur Theorie des photographischen Prozesses. I. Das latente Bild; II. Der Entwicklungsvorgang. *Arch. Wiss. Phot.* **2**: 9. 1900.
- SCHILOW, N., and TIMTSCHENKO, E., Physikalisch-chemische Studien an photographischen Entwicklern. III. Hydrochinon als Induktor. *Zeits. Elektrochem.* **19**: 816. 1913.
- SCHWARZ, J., Exposition und Entwicklung. *Jahrb. Phot.* **12**: 145. 1898; **13**: 259. 1899.
- SHEPPARD, S. E., and MEES, C. E. K., Some points in modern chemical theory and their bearing on development. *Phot. J.* **45**: 241. 1905.
- , —, and MEYER, G., Chemical induction in photographic development. *J. Amer. Chem. Soc.* **42**: 689. 1920.

SENSITOMETRY

- ACWORTH, J., Exposure and development. *Phot. J.* **35**: 361, 1895; **20**: 48. 1895.
- DRIFFIELD, V. C., Control of the development factor. *Phot. J.* **43**: 17. 1903.
- EDWARDS, B. J., Control in development. *Brit. J. Phot.* **41**: 789. 1894.
- FERGUSON, W. B., and HOWARD, B. F., Control of the development factor at various temperatures. *Brit. J. Phot.* **52**: 249. 1905.

THE THEORY OF DEVELOPMENT

- HURTER, F., and DRIFFIELD, V. C., An instrument for the measurement of diffuse daylight, and the actinograph. *J. Soc. Chem. Ind.* **9**: 370. 1890.
- , —, —, —, Exposure and development. *Phot. J.* **35**: 372. 1895.
- , —, —, —, On the accuracy of the grease spot photometer, etc. *J. Soc. Chem. Ind.* **9**: 725. 1890.
- , —, —, —, On the range of light in photographic subjects. *Phot. J.* **36**: 134. 1895-6.
- , —, —, —, Photochemical investigations and a new method of determination of the sensitiveness of photographic plates. *J. Soc. Chem. Ind.* **9**: 455. 1890.
- JONES, L. A., A new non-intermittent sensitometer. *J. Frankl. Inst.* **189**: 303. 1920.
- MEES, C. E. K., and SHEPPARD, S. E., New investigations on the study of light sources. *Phot. J.* **50**: 287. 1910.
- , —, —, —, On instruments for sensitometric investigations, etc. *Phot. J.* **54**: 200. 1914.
- , —, —, —, On the sensitometry of photographic plates. *Phot. J.* **54**: 282. 1914.
- SHEPPARD, S. E., and MEES, C. E. K., On the development factor. *Phot. J.* **43**: 48. 1903.
- , —, —, —, On the highest development factor attainable. *Phot. J.* **43**: 199. 1903.
- STERRY, J., Exposure and development. *Phot. J.* **35**: 371. 1895.
- , —, Exposure and development relatively considered. *Phot. J.* **35**: 288. 1895.
- , —, Light and development. *Phot. J.* **51**: 320. 1911.
- , —, The separation of development into primary and secondary actions. Consequent effect upon the correct rendering of light values, and theory of the latent image. *Brit. J. Phot.* **51**: 315. 1904.
- WATKINS, A., Control in development. *Brit. J. Phot.* **42**: 133. 1895.
- , —, Development. *Brit. J. Phot.* **41**: 745. 1894.
- , —, New methods of speed and gamma testing. *Phot. J.* **52**: 206. 1912.

CHEMISTRY OF DEVELOPING SOLUTIONS

- FRARY, F. C., and NIETZ, A. H., The reaction between alkalis and metol and hydroquinone in photographic developers. *J. Amer. Chem. Soc.* **37**: 2273. 1915.
- LUTHER, R., and LEUBNER, A., The chemistry of hydroquinone development. *Brit. J. Phot.* **59**: 632, 653, 673, 692, 710, 729, 749. 1912.
- SHEPPARD, S. E., and MEES, C. E. K., Investigations on the theory of the photographic process. (Longmans, London, 1907.)

PLATE SPEED DETERMINATIONS

- BENNETT, H. W., Control in development. *Phot. J.* **43**: 74. 1903.
- BLOCH, O., Plate Speeds. *Phot. J.* **57**: 51. 1917.
- DRIFFIELD, V. C., Control of the development factor. *Phot. J.* **43**: 17. 1903.
- HURTER, F., and DRIFFIELD, V. C., Exposure and development. *Phot. J.* **35**: 372. 1895.
- , —, —, —, —, Photochemical investigations and a new method of determination of the sensitiveness of photographic plates. *J. Soc. Chem. Ind.* **9**: 455. 1890.
- , —, —, —, —, The latent image and its development. *Phot. J.* **30**: 360. 1890.

- LEHMANN, E., Zur Theorie der Tiefenentwicklung. *Phot. Runds.* **50**: 55. 1913.
- LÜPPO-CRAMER, Photographische Probleme. (Knapp, Halle a. S., 1907.)
- LUTHER, R., Chemische Vorgänge in der Photographie (Knapp, Halle a. S., 1899.)
- MEES, C. E. K., Time development. *Phot. J.* **50**: 403. 1910.
- PIPER, C. W., The application of physico-chemical theories in plate-testing and experimental work with developers. *Brit. J. Phot.* **60**: 119. 1913.
- RENWICK, F. F., The physical process of development. *Brit. J. Phot.* **58**: 75. 1911.
- SCHAUM, K., Zur Theorie des photographischen Prozesses. *Arch. wiss. Phot.* **2**: 9. 1900.
- SCHILOW, N., and TIMTSCHENKO, E., Physikalisch-chemische Studien an photographischen Entwicklern. III. Hydrochinon als Induktor. *Zeits. Elektrochem.* **19**: 816. 1913.
- SHEPPARD, S. E., Reversibility of photographic development and the retarding action of soluble bromides. *J. Chem. Soc.* **87**: 1311. 1905.
- , —, Theory of alkaline development, with notes on the affinities of certain reducing agents. *J. Chem. Soc.* **89**: 530. 1906.
- , —, and MEES, C. E. K., Investigations on the theory of the photographic process. (Longmans, London, 1907.)
- , —, —, —, —, —, On some points in modern chemical theory and their bearing on development. *Phot. J.* **45**: 241. 1905.
- , —, —, —, —, —, The chemical dynamics of photographic development. *Proc. Roy. Soc.* **74**: 457. 1904.
- , —, —, —, —, —, The theory of photographic processes. Part II. *Phot. J.* **45**: 319. 1905.
- , —, and MEYER, G., Chemical induction and photographic development. *J. Amer. Chem. Soc.* **42**: 689. 1920; *Phot. J.* **60**: 12. 1920.
- VANZETTI, B. L., Diffusion of electrolytes. *Chem. Abst.* **9**: 406. 1915.
- WILDERMANN, M., Ueber die Geschwindigkeit der Reaktion vor vollständigem Gleichgewichte und vor dem Uebergangspunkte, u. s. w. *Zeits. physik. Chem.* **30**: 341. 1899.

Index of Authors

- ABEGG, R., 22, 23
 ANDRESEN, M., 16, 18, 175
 ARMSTRONG, H. E., 22
 BANCROFT, W. D., 15
 BLOCH, O., 84
 BREDIG, G., 15
 COLBY, 79
 DRIFFIELD, V. C., HURTER, F., and
 ———, 22, 25, 30, 32, 33, 59,
 60, 61, 64, 73, 78, 80, 82, 110,
 141, 162, 165
 EDER, J. M., 14
 FRARY, F. C., 29, 147
 ———, and MITCHELL, 147
 ———, and NIETZ, A. H., 29, 57
 HURTER, F., and DRIFFIELD, V. C.,
 22, 25, 30, 32, 33, 59, 60, 61,
 64, 73, 78, 80, 82, 110, 141, 162,
 165
 JONES, L. A., 26
 LEUBNER, A., LUTHER, R., and
 ———, 29, 167
 LUMIÈRE, A., 16, 18, 175
 LUMIÈRE, L., 16, 18
 LÜPPO-CRAMER, 150, 153
 LUTHER, R., 22
 ———, and LEUBNER, A., 29, 167
 MELLOR, 84
 MEES, C. E. K., and PIPER, C. W.,
 136, 137, 139
 ———, and SHEPPARD, S. E., 26
 ———, SHEPPARD, S. E., and
 ———, 18, 25, 29, 30, 32, 33, 80,
 81, 82, 83, 124, 165, 166
 MEYER, G., SHEPPARD, S. E., and
 ———, 77, 153
 MITCHELL, FRARY, F. C., and
 ———, 147
 NERNST, W., 15, 78, 107
 NIETZ, A. H., 92
 ———, FRARY, F. C., and ———,
 29, 57
 OSTWALD, W., 15
 PERLEY, 147
 PIPER, C. W., MEES, C. E. K., and
 ———, 136, 137, 139
 SEYEWETZ, A., 16, 18
 SHEPPARD, S. E., 18, 19, 23, 24,
 25, 32, 36, 57, 78, 79, 82, 92,
 126, 150, 166
 ———, and MEES, C. E. K., 18,
 25, 29, 30, 32, 33, 80, 81, 82, 83,
 124, 165, 166
 ———, and MEYER, G., 77, 153
 ———, MEES, C. E. K., 26
 WATERHOUSE, J., 147
 WILSEY, R. B., 92, 125

Index of Subjects

- Abegg's theory of bromide restraint, 22
——— plan for measuring reduction potential, 23
- Alkyl groups, substitution of, in developer, 17, 18, 176
- Amino groups, substitution of, in developer, 17, 18, 176
- Apparatus used in developing test plates, 27, 28
- Bloch's method of solving velocity equations, 84
- Bromide, Abegg's theory of restraining action of, 22
abnormal effect of soluble, on developer, 150
advantages of, in developer for speed determination, 69, 178
chemical effects of, in developer, 22, 23, 24
effect of soluble, on maximum contrast, 119, 169
—— ———, on density, 19, 24, 32-58, 113, 122, 150, 160-164, 173
—— ———, on fog, 68, 69, 144, 146, 152, 173
—— ———, on maximum density, 113-118, 169
—— ———, on plate curves, 39, 40, 160-164
—— ———, on reduction potential, 109
—— ———, on time of appearance of image, 32, 125, 170
—— ———, on velocity, 112, 113, 124, 126, 130, 169, 170
—— ———, on velocity constant, 124, 170
- Bromide concentration and density depression, 19, 24, 32-58, 122, 160-164, 173
- Bromide concentration giving same maximum density for different emulsions, 116-118, 169
- Carbonate, effect of variable quantities in developer, 72, 156, 157
- Chemical fog, 134, 135, 171
- Contrast, 31
effect of fog on, 101, 143, 166
maximum, determination of, 100
—— ———, effect of bromide on, 119, 169
—— ———, relation of, to reduction potential, 102, 109
—— ———, variation of, with developer, 102-109, 168
- Density, concentration of bromide required to give same maximum, for different developers for same emulsion, 116-118, 169
definition of, 26
growth of, with development, 31
—— ———, with exposure, 31
maximum ——— equation, 78, 79, 83, 88, 97, 165
—— ———, variation with concentration of bromide in developer, 113-118, 169
—— ———, variation with developer, 113-118, 169
—— ———, variation with exposure, 99
—— ———, variation with reduction potential, 102-105, 167
measurement of, 30
- Density depression, due to bromide, 32, 36, 37, 41, 49, 122, 130, 160-164
a measure of the shift of the equilibrium, 122, 170
method of measuring reduction potential by, 19, 24, 32-58, 160-164
rate of, 38, 52, 163
relation to bromide concentration, 38, 41, 49, 163

- Developers, abnormal effects of bromide in, 150, 173
 classification of, according to fogging velocity, 140, 142
 ———— —, according to maximum fog, 142
 ———— —, general, 14
 ———— —, structural, 16, 174, 175
 depression with different ————, in relation to bromide concentration, 49
 effect of changes in constitution of, 72, 155
 ——— — carbonate in, 72, 156, 157
 ——— — hydroquinone in, 72, 156, 157
 ——— — neutral salts in, 150, 153, 154, 173
 ——— — potassium iodide in, 153, 173
 ——— — sulphite in, 72, 156, 157, 158, 168
 energy of, 18, 58, 175
 fogging velocity of, 138, 172
 formulae of, used for test plates, 28
 induction period of, 77
 reduction potential of, 15, 19, 22, 32, 54, 58, 175
 ——— ——— —, chemical theory of method of determining, 19
 ——— ——— —, table of relative, 56, 58, 175
 relation of concentration of ingredients of, to speed, 72, 165
 ——— — different ———— to speed, 67, 69, 70, 71, 165
 relation to fogging, 68, 140, 141, 172
 structure of, and relation to photographic properties, 16, 174, 176
 substitution of alkyl groups in, 17, 18, 176
 ——— — amino groups in, 17, 18, 176
 variation of maximum contrast with, 102-109, 168
 ——— — maximum density with, 102-109, 167
- Development, method of, for standard conditions, 26
 velocity of, 15, 76
- Dichroic fog, 136
- Emulsion, effect of, on value of density depression, 54
 Emulsion fog, 134, 171
 Emulsions used for experimental work, 29
 Energy of developer, 58, 176
 increase of, 18, 176
- Exposure of photographic plates for quantitative measurement, 25
 importance of method of, for speed determination, 59
 variation of maximum density with, 99
- Fog, chemical, 134, 135, 171
 dichroic, 136
 distribution over image, 69, 141, 144-147, 149, 171
 emulsion, 134, 171
 nature of, 134-137, 171
 relation of bromide to, 68, 69, 144, 146, 152, 173
 relation to reduction potential, 68, 136, 137, 172
- Fogging action of thiocarbamide, 136, 147, 172
 Fogging power, 137-141, 171
 Fogging velocity, expression for, 138, 172
 of different developers, 140, 141, 142
- Glycine, effect of change to, in developer, 17, 18, 177

- Hurter and Driffield's method for determining the speed of emulsions, 60
 sensitometric work, 25, 30, 80
 work on velocity, 78, 80, 165
- Hydroquinone, effect of variable quantities of, in developer, 72, 156, 157
- Induction period of developers, 77, 155
- Latent image, development of, 109, 168
 curve for, 109-111
- Maximum contrast, determination of, 100
 effect of bromide on, 119, 169
 relation of, to reduction potential, 102-109
 variation of, with developer, 102-109, 168
- Maximum density, equation, 78, 79, 83, 88, 97, 165
 variation of, with concentration of bromide in developer, 113-118, 169
 ———, with exposure, 99
 ———, with reduction potential, 102-109, 167
- Neutral salts, effect of, in developer, 150, 154, 173
- Nietz's equation for velocity of development, 88, 92, 97, 165
- Potassium bromide, abnormal effect in developer, 150, 173
- Potassium citrate, effect in developer, 154
- Potassium ferrocyanide, effect in developer, 154
- Potassium iodide, effect in developer, 153
- Potassium nitrate, effect in developer, 154
- Potassium oxalate, effect in developer, 154
- Potassium sulphate, effect in developer, 154
- Reduction potential of developers, 15, 19, 22, 32, 54, 56, 58, 107, 108, 113'
 175
 Abegg's plan for measuring, 23
 chemical theory of method of determining, 19
 definition of, 15, 19
 determination of, by density depression method, 19,
 24, 32, 33-58, 122, 160-164
 ———, by maximum density method, 113-
 118, 169
 ———, by Sheppard's method, 32
 ———, by velocity method, 107, 108, 168
 effect of bromide on, 109
 relation to chemical structure, 176
 ——— — fog, 68, 136, 137, 172
 ——— — maximum contrast, 102-109
 ——— — maximum density, 102-109, 167
 ——— — photographic properties, 174
 ——— — speed, 70, 72, 165
 sensitometric theory of determining, 30
 Sheppard's method of measuring, 19, 24, 32
- Sensitometry, 25, 31, 80
- Sensitometric theory of method of determining reduction potentials, 30
- Sheppard's method of measuring reduction potential, 19, 24, 32
 velocity equation, 78
- Sheppard and Mees' work on velocity of development, 81, 82, 124, 165
 sensitometric work, 25, 30, 80

- Speed of emulsions, 59, 164
 definition of absolute, 65
 determination of, 59, 62
 determination by Hurter and Driffield's method, 60
 —————, precision of method of, 73
 effect of bromide on, 68, 165
 ——— — changing concentration of ingredients of
 developers on, 72, 165
 ——— — different developers on, 67, 69, 70, 71, 165
 ——— — contrast, 64
 ——— — reduction potential of developers, 70, 72, 165
 relation to exposure, 59
 variation with different emulsions, 66
- Sulphite, effect of variable quantities in developer, 72, 156, 157, 158, 168
- Thiocarbamide, fogging action of, 136, 147, 172
- Time of appearance of latent image, 32
 effect of soluble bromide on, 32, 125, 170
- Velocity of development, 76
 Bloch's method of solving equations for, 84
 of fog, 138, 172
 determination of, 76, 80
 ————— —, reduction potential by, 107,
 108, 168
 effect of diffusion on, 78, 83
 ——— — soluble bromides on, 113, 124, 126, 130,
 170
 ——— — two successive reactions on (Mellor), 84
 equations, 78, 79, 83, 88, 97, 165
 Nernst's theory for reaction —————, 78
 Nietz's equation for, 88, 92, 97, 165
 Sheppard's equation for, 78
 Wilsey's equation for, 92
- Velocity curves, depression of, 130, 170
 effect of bromide concentration on, 126, 170
- Wilsey's equation for velocity of development, 92

YC 61434

GENERAL LIBRARY - U.C. BERKELEY



8000921469

53324

TR 295

N5

UNIVERSITY OF CALIFORNIA LIBRARY

